

JVC[®]

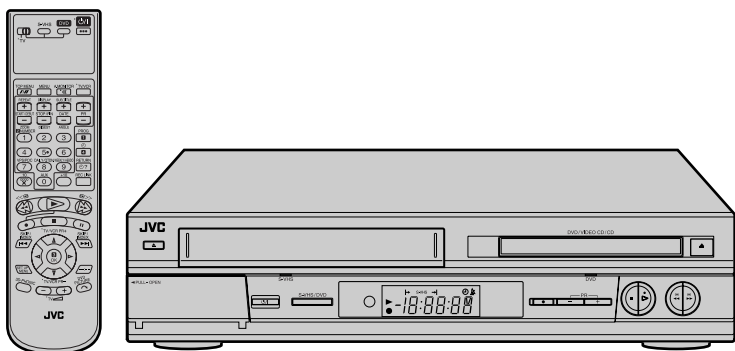

DVD PLAYER & VIDEO CASSETTE RECORDER

HR-XVS20AA



G-CODE[™] / SHOWVIEW[™]

Hi-Fi

S VHS
525/625

Super VHS ET

DVD
VIDEO[™]

dts

DOLBY
DIGITAL

COMPACT
disc
DIGITAL VIDEO

COMPACT
disc
DIGITAL AUDIO

COMPACT
disc
SUPER VIDEO

3D
3D-PHONIC

INSTRUCTIONS

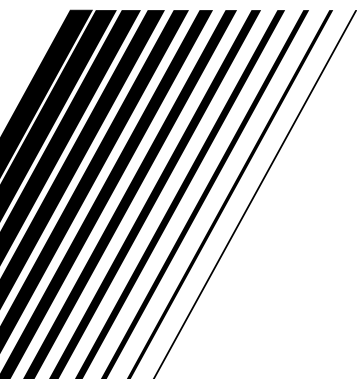

LPT0762-001B

EN

Safety Precautions

The rating plate and the safety caution are on the rear of the unit.

WARNING: DANGEROUS VOLTAGE INSIDE

WARNING: TO PREVENT FIRE OR SHOCK HAZARD, DO NOT EXPOSE THIS UNIT TO RAIN OR MOISTURE.

CAUTION

- When you are not using the unit for a long period of time, it is recommended that you disconnect the power cord from the mains outlet.
- Dangerous voltage inside. Refer internal servicing to qualified service personnel. To prevent electric shock or fire hazard, remove the power cord from the mains outlet prior to connecting or disconnecting any signal lead or aerial.

CAUTION

A DVD/VCR IS A CLASS 1 LASER PRODUCT. HOWEVER THIS DVD/VCR USES A VISIBLE LASER BEAM WHICH COULD CAUSE HAZARDOUS RADIATION EXPOSURE IF DIRECTED. BE SURE TO OPERATE THE UNIT CORRECTLY AS INSTRUCTED.

WHEN THIS DVD/VCR IS PLUGGED INTO THE WALL OUTLET, DO NOT PLACE YOUR EYES CLOSE TO THE OPENING OF THE DISC TRAY AND OTHER OPENINGS TO LOOK INTO THE INSIDE OF THIS DVD/VCR.

USE OF CONTROLS OR ADJUSTMENTS OR PERFORMANCE OF PROCEDURES OTHER THAN THOSE SPECIFIED HEREIN MAY RESULT IN HAZARDOUS RADIATION EXPOSURE.

DO NOT OPEN COVERS AND DO NOT REPAIR YOURSELF. REFER SERVICING TO QUALIFIED PERSONNEL.

ATTENTION (S-VHS deck only)

1. This unit can also receive SECAM colour television signals for recording and playback.
2. Recordings made of SECAM television signals produce monochrome pictures if played back on another video recorder of SECAM standard, or do not produce normal colour pictures if played back on another video recorder of PAL standard.
3. SECAM prerecorded cassettes or recordings made with a SECAM video recorder produce monochrome pictures when played back with this unit.

IMPORTANT

- Please read the various precautions on pages 2 and 3 before installing or operating the unit.
- It should be noted that it may be unlawful to re-record pre-recorded tapes, DVDs, or discs without the consent of the owner of copyright in the sound or video recording, broadcast or cable programme and in any literary, dramatic, musical, or artistic work embodied therein.

Use only discs marked with the following.



DVD
(8 cm /12 cm disc)



Video CDs
(8 cm /12 cm disc)



Audio CDs
(8 cm /12 cm disc)



- Manufactured under license from Dolby Laboratories. "Dolby" and double-D symbol are trademarks of Dolby Laboratories. Confidential Unpublished Works.
© 1992-1997 Dolby Laboratories, Inc. All rights reserved.
- Manufactured under license from Digital Theater Systems, Inc. US Pat. No. 5,451,942 and other world-wide patents issued and pending. "DTS" is registered trademark of Digital Theater Systems, Inc.
Copyright 1996 Digital Theater Systems, Inc. All rights reserved.
- Cassettes marked "S-VHS" and "VHS" can be used with this unit. However, S-VHS recordings are possible only with cassettes marked "S-VHS".
By using the S-VHS ET function, it is possible to record and play back with S-VHS picture quality on VHS cassettes with this unit.
- G-CODE is a trademark of Gemstar Development Corporation and is registered in the following countries: Australia, China, Hong Kong, Japan, South Korea, New Zealand, and Taiwan. SHOWVIEW is a trademark of Gemstar Development Corporation and is registered in the following countries: Austria, Belgium, Czech Republic, Denmark, Finland, France, Germany, Greece, Hungary, Iceland, Italy, Luxembourg, Netherlands, Norway, Poland, Portugal, Russia, Slovakia, South Africa, Spain, Sweden and Switzerland. The G-CODE/SHOWVIEW system is manufactured under license from Gemstar Development Corporation.
G-CODE and SHOWVIEW are different trademarks used to represent the same easy recording feature. However, for simplicity, only the term G-CODE will be used in the instructions. If you use SHOWVIEW system, follow the same steps listed for the G-CODE system.
- This product incorporates copyright protection technology that is protected by method claims of certain U.S. patents and other intellectual property rights owned by Macrovision Corporation and other rights owners. Use of this copyright protection technology must be authorized by Macrovision Corporation, and is intended for home and other limited viewing users only unless otherwise authorized by Macrovision Corporation. Reverse engineering or disassembly is prohibited.

POWER SYSTEM:

This unit operates on voltage of AC110 – 240 V \sim (Rating), AC90 – 260 V \sim (Operating), 50/60 Hz with automatic switching.

The STANDBY/ON ϕ /I button does not completely shut off mains power from the unit, but switches operating current on and off. “ ϕ ” shows electrical power standby and “I” shows ON.

Video tapes recorded with this unit in the LP/EP (Long Play/Extended Play) mode cannot be played back on a single-speed video recorder. (S-VHS deck only)

When the equipment is installed in a cabinet or a shelf, make sure that it has sufficient space on all sides to allow for ventilation (10 cm or more on both sides, on top and at the rear.)

When discarding batteries, environmental problems must be considered and the local rules or laws governing the disposal of these batteries must be followed strictly.

Failure to heed the following precautions may result in damage to the unit, remote control or video cassette.

1. **DO NOT place the unit** —
 - in an environment prone to extreme temperatures or humidity.
 - in direct sunlight.
 - in a dusty environment.
 - in an environment where strong magnetic fields are generated.
 - on a surface that is unstable or subject to vibration.
2. **DO NOT block the unit's ventilation openings or holes.**
(If the ventilation openings or holes are blocked by a newspaper or cloth, etc., the heat may not be able to get out.)
3. **DO NOT place heavy objects on the unit or remote control.**
4. **DO NOT place anything which might spill on top of the unit or remote control.**
(If water or liquid is allowed to enter this equipment, fire or electric shock may be caused.)
5. **DO NOT expose the apparatus to dripping or splashing.**
6. **DO NOT use this equipment in a bathroom or places with water. Also DO NOT place any containers filled with water or liquids (such as cosmetics or medicines, flower vases, potted plants, cups, etc.) on top of this unit.**
7. **DO NOT place any naked flame sources, such as lighted candles, on the apparatus.**
8. **AVOID violent shocks to the unit during transport.**

MOISTURE CONDENSATION

Moisture in the air will condense on the unit when you move it from a cold place to a warm place, or under extremely humid conditions—just as water droplets form in the surface of a glass filled with cold liquid. Moisture condensation on the head drum will cause damage to the tape. In conditions where condensation may occur, keep the unit turned on for a few hours to let the moisture dry.

ATTENTION**To mobile phone users:**

Using a mobile phone in the vicinity of the unit may cause picture vibration on the TV screen or change the screen to a blue back display.

On placing the unit:

Some TVs or other appliances generates strong magnetic fields. Do not place such appliance on top of the unit as it may cause picture disturbance.

SAFETY FIRST	2	EDITING (S-VHS DECK)	68
Safety Precautions	2	Edit From A Camcorder	68
DISC INFORMATION	5	Edit To Or From Another Video Recorder	69
About Discs	5	Dubbing (from DVD to S-VHS)	70
INDEX	8	EDITING (DVD DECK)	71
INSTALLING YOUR NEW UNIT	12	Digital Audio Dubbing	71
Basic Connections	12	REMOTE CONTROL	72
S-VIDEO Connection	13	Remote Control Functions	72
Component Video Connection (DVD deck only)	14	SYSTEM CONNECTIONS	74
INITIAL SETTINGS	15	Connecting To A Satellite Receiver	74
Video Channel Set	15	Connecting To A Dolby Digital Decoder or An Amplifier With A Built-in DTS (DVD deck only)	75
Auto Set Up	16	SUBSIDIARY SETTINGS	76
Monitor Set (DVD deck)	18	Mode Set (S-VHS deck)	76
Scan Mode Set (DVD deck)	19	Mode Set (DVD deck)	80
Language	20	Tuner Set	83
OPERATIONS ON S-VHS DECK	23	Clock Set	87
Basic Playback	23	Information on Multi-System Compatibility (S-VHS deck only)	88
Playback Features	24	TROUBLESHOOTING	90
Basic Recording	27	QUESTIONS AND ANSWERS	95
Recording Features	28	SPECIFICATIONS	96
B.E.S.T. Picture System	30	LIST OF TERMS	97
G-CODE™/SHOWVIEW™ System Setup	31		
G-CODE™/SHOWVIEW™ Timer Programming	32		
Express Timer Programming	34		
Automatic Satellite Programme Recording	39		
OPERATIONS ON DVD DECK	40		
Basic Playback	40		
Playback Features	41		
Using the on-screen bar	48		
Parental Lock	58		
About MP3 Disc	62		
MP3 Playback	63		
About JPEG Disc	65		
JPEG Playback	66		

About Discs

Playable Discs

You can use the discs with the following logos for playback only.

<p>DVD VIDEO</p> 	<p>Video CD/Super Video CD</p> 
<p>Music CD</p>  <p>CD-DA files</p>	<p>CD-R</p>  <p>CD-DA/JPEG/MP3 files</p>
<p>CD-RW</p>  <p>JPEG/CD-DA/MP3 files</p>	<p>CD-ROM</p>  <p>JPEG/MP3 files</p>

- Discs other than the above cannot be played back.
 - DVD video discs have a region number. Discs whose region number includes "ALL" or "4" can be played back on this unit.
 - Operation and audio quality of this unit are not guaranteed for discs that do not conform to the Compact Disc specification (CD-DA).
- Before you play back a CD, check for the CD logo and read the notes on the package to confirm that it conforms to the Compact Disc specification.
- Depending on the intentions of the author of the software, recording conditions of DVD discs and Video CD discs may be restricted. Since this unit plays back discs according to the intentions of the author of the software as indicated on the disc, some functions may not operate as commanded.
 - When switching from the first layer to the second layer of double-layered DVD VIDEO discs, the image and sound may be momentarily distorted. This is not a malfunction.

Unplayable Discs

The following types of discs cannot be played using this unit. Do not attempt to play back any kind of disc that is damaged (cracked, warped, or repaired with adhesive tape) or discs in unusual shapes (heart-shaped, octagonal, or other forms). If such discs are accidentally played back, it may cause noise that can lead to speaker damage.

- CD-ROM discs (including PHOTO-CD)
- DVD AUDIO discs
- Super Audio CDs (SACD)
- 1.3-GB double density CDs (DDCD)

The following discs also cannot be played back.

- Discs which have a region number other than "4"
- DVD+RW formatted discs
- DVD-RW formatted discs
- DVD-RAM









Region Number

The world is divided into 6 regions for DVD VIDEO discs. DVD VIDEO discs are assigned a region number to indicate which region they may be played back in. A disc cannot be played back on this unit unless the region number of the disc matches that of the unit. The region number for this unit is "4". Only discs whose region number includes "4" can be played back such as shown below.

Examples of DVD VIDEO labels which can be played back using this unit.









Marks of discs in this instruction manual

	Allows operation with a DVD VIDEO disc.		Allows operation with a CD-R/RW disc.
	Allows operation with a Video CD disc.		Allows operation with a SVCD disc.
	Allows operation with a disc including MP3 files.		Allows operation with a disc including JPEG files.
	Allows operation with a Audio CD disc.		Allows operation with a CD-ROM disc.



DVD VIDEO Marks

Sometimes marks are printed on a DVD disc and/or on its packaging to indicate information regarding the contents and functions of a disc. Check marks indicating the contents and functions of a disc. Note, however, that in some cases a disc may not include a mark even for a function it supports.

Marks related to video

Mark	Description
	Number of subtitles
	Number of angles
	Recorded under the standard 4:3 aspect ratio
	Screen includes black bands at top and bottom of image which has a standard 4:3 aspect ratio (letter box)
	Video playback is in Wide video mode (16:9) on wide televisions, but in letter box on televisions with standard 4:3 aspect ratio.
	Video playback is in Wide video mode (16:9) on wide televisions, but pan and scan is used on televisions with standard 4:3 aspect ratio (either the left or right side of the image is cut-out).

Marks related to audio

Mark	Description
	Number of audio tracks
	Dolby Digital mark Dolby Laboratories has developed a digital surround system for the home. This mark indicates that you may enjoy 5.1-channel audio (front left and right, center, rear left and right, and a channel for LFE (Low-Frequency Effects)).
	DTS (Digital Theater System) The DTS decoder on this unit enables you to enjoy DTS audio with the connected TV's speakers by converting 5.1 channel audio signals into 2 channel signals (DTS Down Mixing). The decoder also outputs the original DTS 5.1 channel audio signals from the DIGITAL AUDIO OUT connector on this unit.

File Structure of Discs

DVD VIDEO

Typically, DVD VIDEO discs are made up of larger units called "titles". Each title has a number (title number) that can be used to select desired titles. Titles are further divided into units called "chapters". Each chapter has a number (chapter number) that can also be used to select desired chapters. Note that some discs are not divided into titles and chapters.

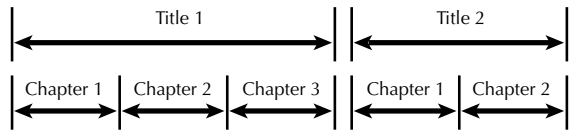

Audio CD/Video CD

Typically, Audio CD discs are divided into separate tracks each containing one song. Each track is assigned a number. For example, the third track is Track 3. The same is true for Video CD discs.

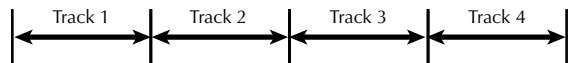

NOTE:

Video CD discs that support Playback Control (PBC)

The still image or motion image which follows a menu screen is called a "scene". Each scene has a scene number.

For more details, refer to "Locating a desired scene using the menu of the Video CD with PBC" (pg. 41).

Placing a Disc

1 Open the disc tray.

Press ▲ on the DVD deck to open the disc tray.

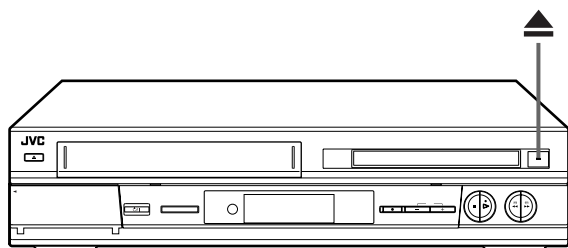

- Pressing the button again closes the disc tray.
- Do not block the disc tray with your hand while it is opening or closing as this may result in hardware failure.
- Do not place unplayable discs or any object other than a disc in the disc tray.
- Do not press down strongly on the disc tray or place any heavy objects on it.

2 Place the disc.

Place the disc in the disc tray with the label side facing up.

- Since disc size changes depending on the disc to be played back, be sure to correctly align the disc with the grooves for its size. If the disc is not in its groove, it may be scratched or otherwise damaged.
- To insert an 8 cm disc, place it according to the inner groove.

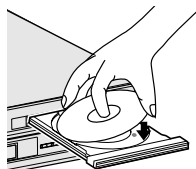

Care and Handling of Discs

How to handle discs

When handling a disc, do not touch the surface of the disc. Since discs are made of plastic, they are easily damaged. If a disc gets dirty, dusty, scratched or warped, the images and sound will not be picked up correctly, and such a disc may cause the unit to malfunction.

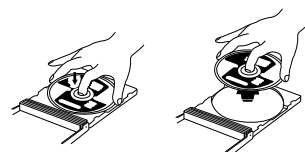

Label side

Do not damage the label side, stick paper to or use any adhesive on its surface.

Storage

Make sure that discs are kept in their cases. If discs are piled on top of one another without their protective cases, they can be damaged. Do not put discs in a location where they may be exposed to direct sunlight, or in a place where the humidity or temperature is high. Avoid leaving discs in your car!

Maintenance of discs

If there are fingerprints or other dirt adhering to a disc, wipe with a soft dry cloth, moving from the center outwards. If a disc is difficult to clean, wipe with a cloth moistened with water. Never use record cleaners, petrol, alcohol or any anti-static agents.



CAUTION

Sometimes during playback, noise or images may be garbled. This is sometimes due to the disc. (It may not be up to industry standards.)

These symptoms are caused by the discs, not by the malfunction of the unit.

FRONT VIEW

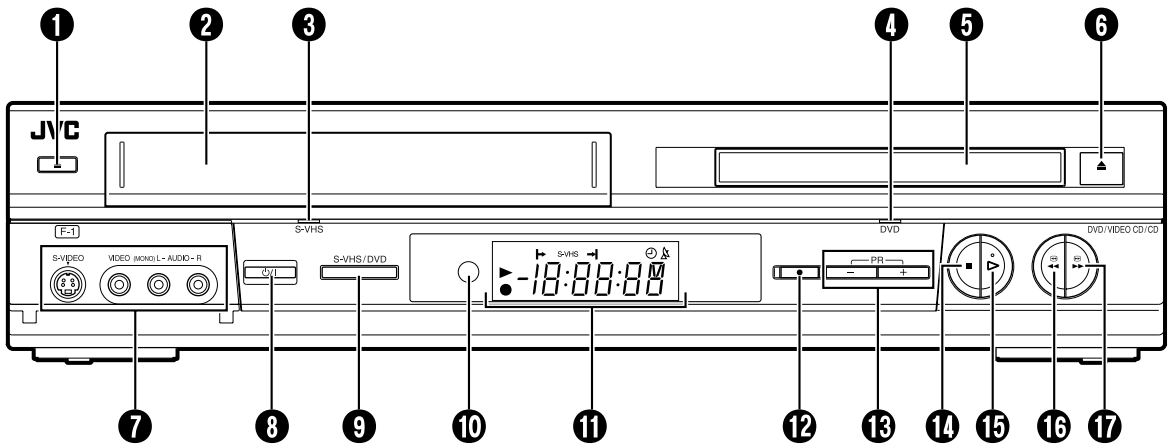

- ① S-VHS Eject Button (▲) ☞ pg. 23, 27
- ② S-VHS Cassette Loading Slot ☞ pg. 23, 27
- ③ S-VHS Indicator ☞ pg. 23, 27
- ④ DVD Indicator ☞ pg. 40
- Scan Mode Indicator* ☞ pg. 19
- * You can switch the scan mode by pressing and hold **DVD PICTURE** for more than 5 seconds.
The Scan Mode indicator lights up as described below.
Green: in the Interlace mode
Red: in the Progressive mode
- ⑤ Disc Tray
- ⑥ DVD Eject Button (▲) ☞ pg. 40
- ⑦ S-video/Video/Audio Input Connectors (S-VIDEO/VIDEO/AUDIO) ☞ pg. 68
- ⑧ STANDBY/ON Button (⏻/⏻) ☞ pg. 16
- ⑨ S-VHS/DVD Slot ☞ pg. 23, 27, 40
- ⑩ Infrared Beam Receiving Window ☞ pg. 9
- ⑪ Front Display Panel ☞ pg. 9
- ⑫ Record Button (●) ☞ pg. 27
- ⑬ Programme Button (PR +/-) ☞ pg. 27
- ⑭ Stop Button (■) ☞ pg. 23, 27, 40
- ⑮ Play Button (▶) ☞ pg. 23, 40
- ⑯ Rewind Button (◀◀) ☞ pg. 23, 24, 43
- ⑰ Fast Forward Button (▶▶) ☞ pg. 23, 24, 43

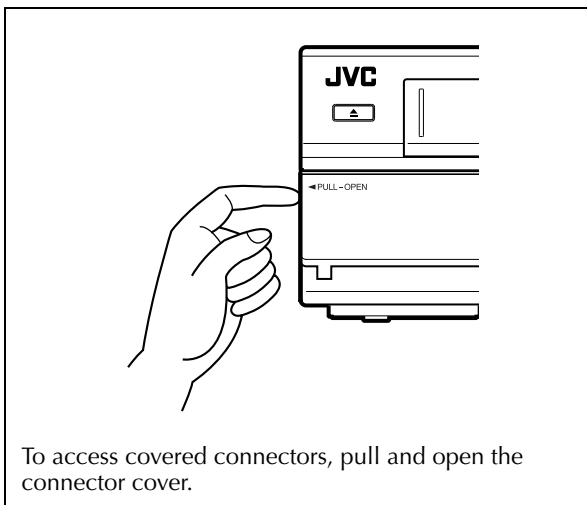

To access covered connectors, pull and open the connector cover.

REAR VIEW

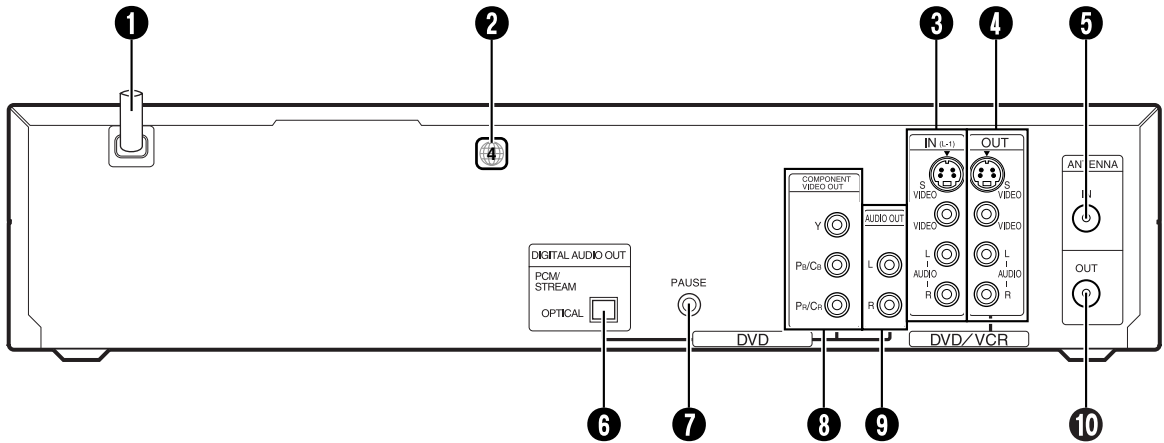

- ❶ Mains Power Cord ☞ pg. 12
- ❷ Region Number Label ☞ pg. 5
- ❸ S-video/Video/Audio Input Connectors (S-VIDEO/VIDEO/AUDIO IN) ☞ pg. 69
- ❹ S-video/Video/Audio Output Connectors (S-VIDEO/VIDEO/AUDIO OUT) ☞ pg. 12, 13, 14, 69
- ❺ Antenna Input Connector (ANTENNA IN) ☞ pg. 12
- ❻ Digital Audio Output Connector (DIGITAL AUDIO OUT) ☞ pg. 71
- ❼ Remote Pause Connector (PAUSE) ☞ pg. 68
- ❽ Component Video Output Connectors (COMPONENT VIDEO OUT) ☞ pg. 14
- ❾ Audio Output Connectors (AUDIO OUT (L/R))*
* These are analogue audio output connectors for DVD.
- ❿ Antenna Output Connector (ANTENNA OUT) ☞ pg. 12

FRONT DISPLAY PANEL

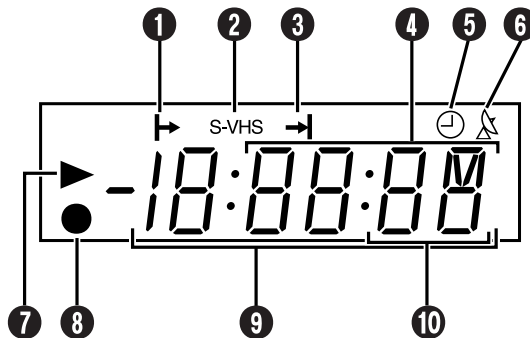

- ❶ Start Time Indicator (▶) (S-VHS deck only) ☞ pg. 34
- ❷ S-VHS Indicator (S-VHS deck only) ☞ pg. 77, 79
- ❸ Stop Time Indicator (▶) (S-VHS deck only) ☞ pg. 34
- ❹ Channel/Clock Remain Display (S-VHS deck only) ☞ pg. 29
Mode Display (L-1, F-1, S-1 or S-2) (S-VHS deck only)
- ❺ "Timer" Indicator (S-VHS deck only) ☞ pg. 33, 35
- ❻ Automatic Satellite Programme Recording Indicator (⚡) (S-VHS deck only) ☞ pg. 39
- ❼ Play Indicator
- ❽ Record Indicator (S-VHS deck only)
- ❾ Multi-information window* (DVD deck)
Counter Display (S-VHS deck)
* The current group/title/track/chapter number(s), time and status information.
- ❿ Tape Speed (SP/LP/EP*) (S-VHS deck only) ☞ pg. 27
* EP is for NTSC only.

ON-SCREEN DISPLAY (S-VHS deck)

When "O.S.D." is set to "ON" (☞ pg. 78), various operational indicators appear on the TV screen. For On-screen display for DVD deck, refer to "Using the on-screen bar" (☞ pg. 48).

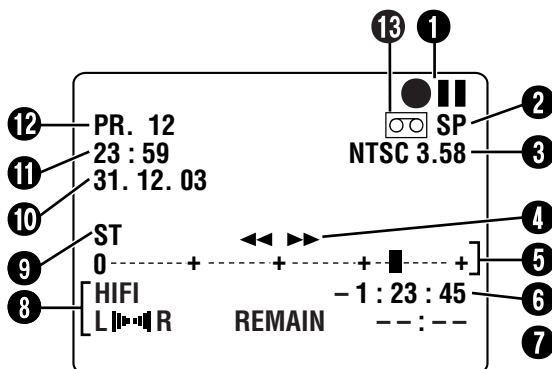

❶ Operation Mode Indicators

❷ Tape Speed (SP/LP/EP*)

* EP is for NTSC only.

❸ Colour System Indicator

❹ Tape Direction

❺ Tape Position Indicator

The tape position indicator appears on the TV screen when you press ◀◀ or ▶▶ from the Stop mode or perform an Index Search. (☞ pg. 25) The position of "■" in relation to "0" (beginning) or "+" (end) shows you where you are on the tape.

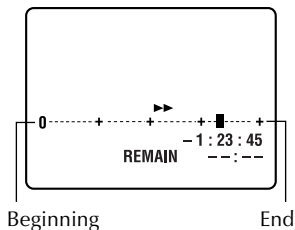

❻ Counter Display

❼ Tape Remaining Time Indicator ☞ pg. 29

❽ Audio Mode Display ☞ pg. 26

❾ Type of Broadcast ☞ pg. 29

❿ Current Day/Month/Year

⓫ Clock Display

⓬ Channel Position Number and Station Name/
Auxiliary Input Indicator (L-1, F-1, S-1 or S-2)

⓭ "Cassette Loaded" Mark

NOTE:

Depending on the type of tape being used, the tape position indicator may not appear correctly.

REMOTE CONTROL

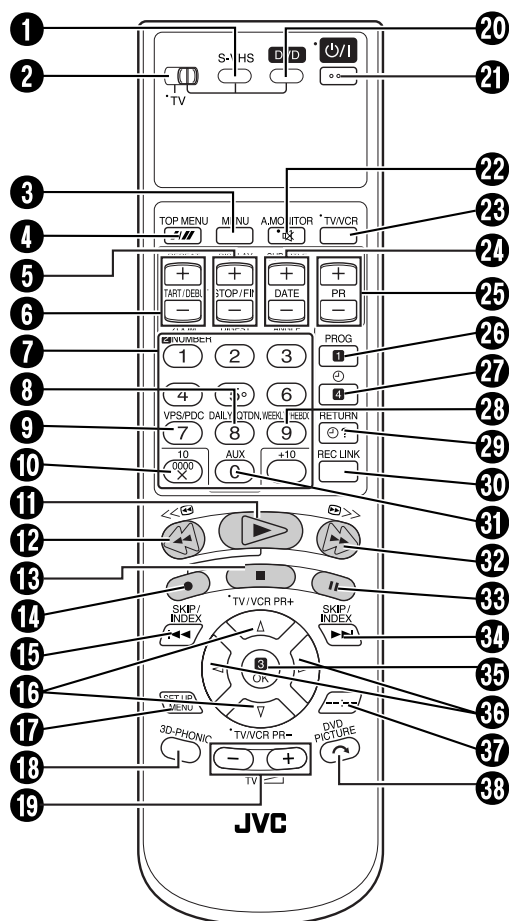

The glow-in-the-dark buttons shown in grey on the illustration above are helpful when using the remote control in darkened rooms.

Buttons with a small dot on the left side of the name can also be used to operate your TV. (☞ pg. 73)

- ① S-VHS Button ☞ pg. 23, 27
- ② TV/S-VHS/DVD switch ☞ pg. 18
- ③ Menu Button (MENU) ☞ pg. 42
- ④ Auto Tracking Button (///) ☞ pg. 26
SP/LP/EP Button ☞ pg. 27
Top Menu Button (TOP MENU) ☞ pg. 42
- ⑤ Stop Time Button (STOP +/-) ☞ pg. 34
Display Button (DISPLAY) ☞ pg. 48
Digest Button (DIGEST) ☞ pg. 44
- ⑥ Start Time Button (START +/-) ☞ pg. 34
Repeat Button (REPEAT) ☞ pg. 50 – 53, 64, 67
Zooming Button (ZOOM) ☞ pg. 45
- ⑦ Number Keys ☞ pg. 27, 32, 64
- ⑧ Daily Button (DAILY) ☞ pg. 33, 35
- ⑨ VPS/PDC Button*

* Not function with this unit.

- ⑩ Reset Button (0000) ☞ pg. 29
Cancel Button (X) ☞ pg. 37
- ⑪ Play Button (▶) ☞ pg. 23, 40
- ⑫ Rewind Button (◀◀) ☞ pg. 23, 24, 43
- ⑬ Stop Button (■) ☞ pg. 23, 27, 40
- ⑭ Record Button (●) ☞ pg. 27
- ⑮ Reverse Skip/Index Button (◀◀) ☞ pg. 25, 41
- ⑯ △▽ Button ☞ pg. 16
TV/VCR Programme Button (TV/VCR PR +/-)
☞ pg. 73
- ⑰ Set Up Menu Button (SET UP MENU) ☞ pg. 18
- ⑱ 3D-PHONIC Button ☞ pg. 46
- ⑲ TV Volume Button (TV ▲/▼) ☞ pg. 73
- ⑳ DVD Button ☞ pg. 40
- ㉑ STANDBY/ON Button (⏻/⏻) ☞ pg. 16
- ㉒ TV Muting Button (🔇) ☞ pg. 73
Audio Monitor Button (A.MONITOR)
☞ pg. 26, 56, 57
- ㉓ TV/VCR Button
- ㉔ Date Button (DATE +/-) ☞ pg. 34
Subtitle Button (SUB TITLE) ☞ pg. 54
Angle Button (ANGLE) ☞ pg. 55
- ㉕ Programme Button (PR +/-) ☞ pg. 27
- ㉖ Programming Button (PROG) ☞ pg. 32, 34
- ㉗ Timer Button (⌚) ☞ pg. 33, 35
- ㉘ Weekly Button (WEEKLY) ☞ pg. 33, 35
- ㉙ Programme Check Button (⌚ ?) ☞ pg. 36
- ㉚ Automatic Satellite Programming Button
(REC LINK) ☞ pg. 39
- ㉛ Auxiliary Button (AUX) ☞ pg. 68
- ㉜ Fast Forward Button (▶▶) ☞ pg. 23, 24, 43
- ㉝ Pause Button (⏸) ☞ pg. 24, 27
- ㉞ Forward Skip/Index Button (▶▶) ☞ pg. 25, 41
- ㉟ OK Button ☞ pg. 15
- ㊱ ◀ ▶ Button ☞ pg. 18
- ㊲ Display Button (---) ☞ pg. 29
- ㊳ Skip Search Button (↶) ☞ pg. 25
DVD Picture Button (DVD PICTURE) ☞ pg. 47

How To Use

The remote control can operate most of your unit's functions, as well as basic functions of TV sets of JVC and other brands. (☞ pg. 73)

- Point the remote control toward the receiving window.
- The maximum operating distance of the remote control is about 8 m.

NOTES:

- When inserting the batteries, be sure to insert in the correct directions as indicated under the battery cover.
- If the remote control doesn't work properly, remove its batteries, wait a short time, replace the batteries and then try again.

Basic Connections

Aerial connector

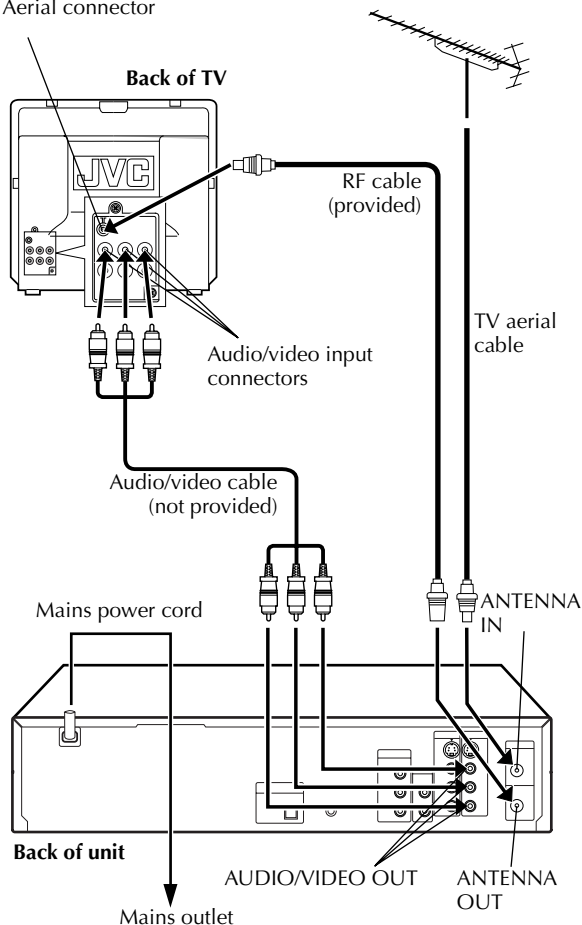

Make AV connection if your TV has audio/video input connectors in order to reduce the possibility of interference. With AV connection, you can enjoy stereo playback of video tapes if you are using a stereo TV.

NOTES:

- For switching the TV's mode, refer to the instruction manual of your television.
- To obtain high-quality pictures, you can also use the S-VIDEO connection and Component Video Connection. (DVD deck only) (☞ pg. 13, 14)

It's essential that your unit be properly connected.

THESE STEPS MUST BE COMPLETED BEFORE ANY VIDEO OPERATION CAN BE PERFORMED.

1 Check the contents.

Make sure the package contains all of the accessories listed in "SPECIFICATIONS" on page 96.

2 Situate the unit.

Place the unit on a stable, horizontal surface.

3 Connect the unit to TV.

The connection method you use depends on the type of TV you have.

RF Connection

■ To connect to a TV with NO AV input connectors —

- 1 Disconnect the TV aerial cable from the TV.
- 2 Connect the TV aerial cable to the ANTENNA IN connector on the rear panel of the unit.
- 3 Connect the provided RF cable between the ANTENNA OUT connector on the rear panel of the unit and the TV's aerial connector.

AV Connection

■ To connect to a TV with AV input connectors —

- 1 Connect the aerial, unit and TV as per "RF Connection".
- 2 Connect the audio/video cable between the AUDIO/VIDEO OUT connectors on the rear panel of the unit and the TV's audio/video input connectors.

4 Connect the unit to mains.

Plug the end of the mains power cord into a mains outlet.

After the connection is completed, perform "Video Channel Set" on page 15.

S-VIDEO Connection

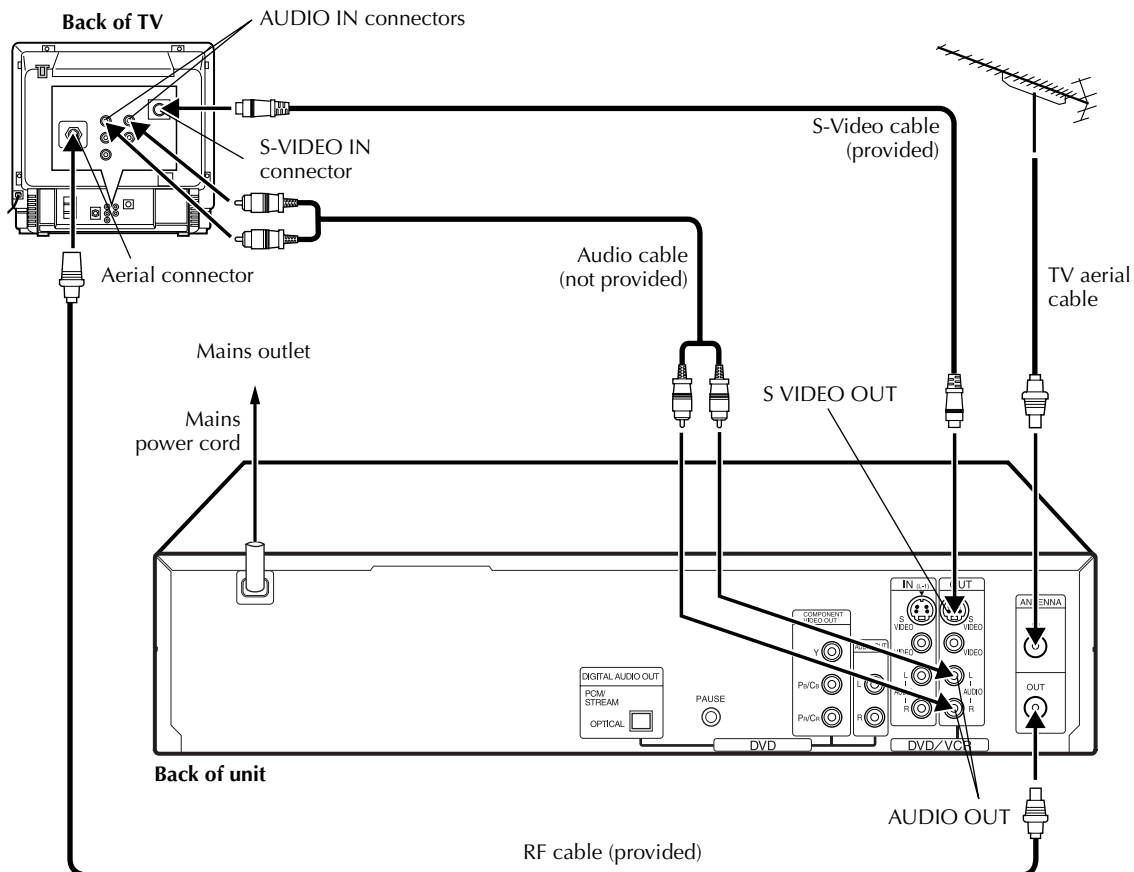

■ To connect to a TV with S-VIDEO/AUDIO IN connectors . . .

1 Connect the unit to TV.

- 1 Connect the aerial, unit and TV as per "RF Connection". (☞ pg. 12)
- 2 Connect the unit's S VIDEO OUT connector to the TV's S-VIDEO IN connector.
- 3 Connect the unit's AUDIO OUT connectors to the TV's AUDIO IN connectors.

2 Connect the unit to mains.

Plug the end of the mains power cord into a mains outlet.

NOTES:

- You can obtain high-quality S-VHS pictures.
- If your TV is not stereo-capable, use the unit's AUDIO OUT connectors to connect to an audio amplifier for Hi-Fi stereo sound reproduction.
- For switching the TV's mode, refer to the instruction manual of your television.

After the connection is completed, perform "Video Channel Set" on page 15.

Component Video Connection

(DVD deck only)

ATTENTION

Be sure to connect the unit's VIDEO OUT or S VIDEO OUT connector to the TV's VIDEO IN or S-VIDEO IN connector.

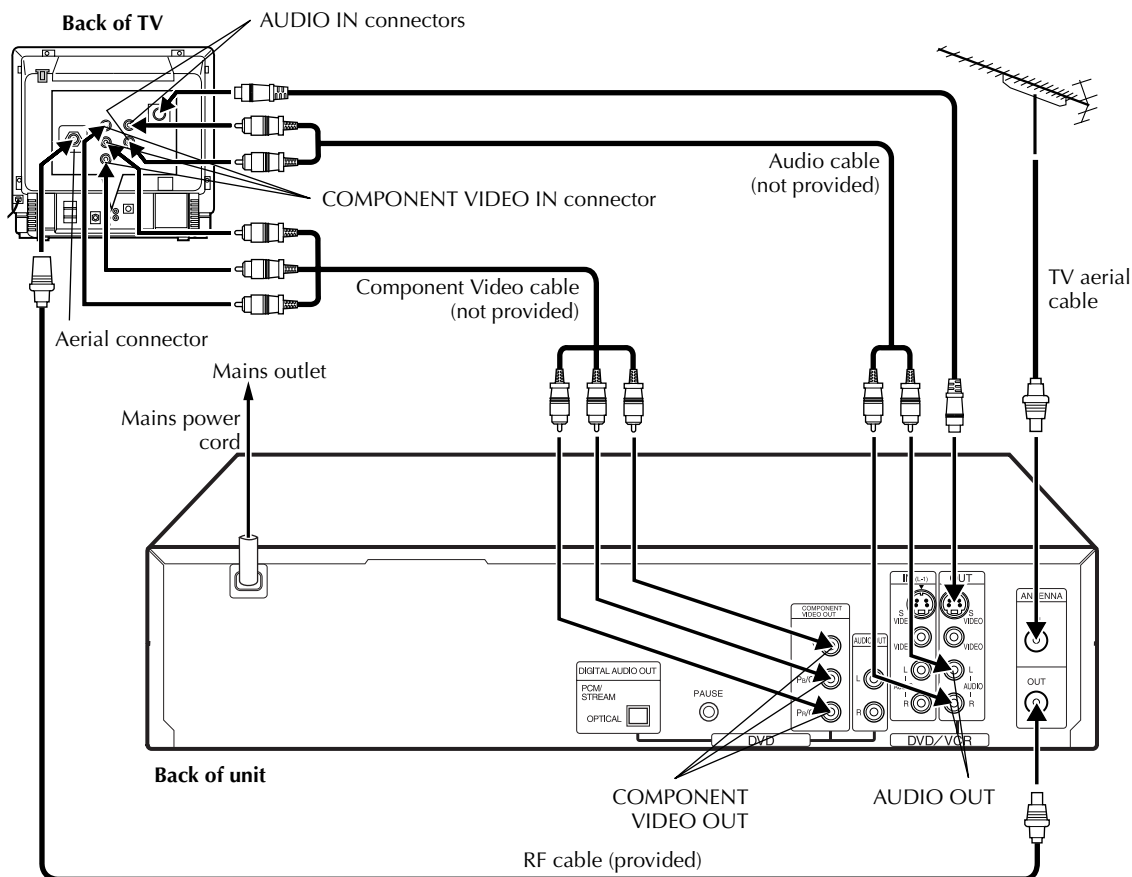

■ To connect to a TV with COMPONENT VIDEO IN connectors . . .

2

Connect the unit to mains.

Plug the end of the mains power cord into a mains outlet.

NOTES:

- You can obtain high-quality component video pictures.
- If your TV is not stereo-capable, use the unit's AUDIO OUT connectors to connect to an audio amplifier for Hi-Fi stereo sound reproduction.
- For switching the TV's mode, refer to the instruction manual of your television.

1

Connect the unit to TV.

- 1 Connect the aerial, unit and TV as per "AV Connection" or "S-VIDEO Connection". (pg. 12, 13)
- 2 Connect the unit's COMPONENT VIDEO OUT connectors to the TV's COMPONENT VIDEO IN connectors.
- 3 Connect the unit's AUDIO OUT connectors to the TV's AUDIO IN connectors.

After the connection is completed, perform "Video Channel Set" on page 15.

Video Channel Set

Video channel (RF output channel) is the channel on which your TV receives picture and sound signals from the unit through the RF cable.

Before performing the following steps:

Make sure there is no cassette inserted in the unit.

Press **S-VHS** so that S-VHS indicator lights up, then press O/I to turn off the unit.

1 Access the Video Channel Set mode.

Hold down \blacksquare on the unit until the front display panel shows the following.

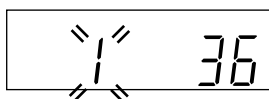

2 Set the TV system. (RF Connection only)

Press **PR +** or **-** on the remote control to set the appropriate TV system that matches the system of TV being used (refer to the table below).

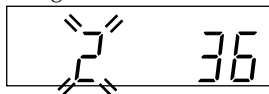

1:B/G 2:D/K 3:I 4:H

Major Countries/Areas	TV System
New Zealand, Kuwait, U.A.E., Indonesia, Singapore, Thailand, Malaysia, Iran, Saudi Arabia, Egypt, Morocco, Lebanon, Iraq	B/G
China, Mongolia, Russia	D/K
Hong Kong	I
Australia	H

3 Set the video channel.

With AV or S-VIDEO Connection

Press **OK**, then press **PR -** until the front display panel shows "--".

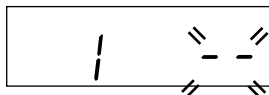

- Now the video channel is set to off.

With RF Connection

Set your TV to UHF channel 36.

- If the two vertical white bars appear clearly on the TV screen as shown on the right, press **OK** and then go to step 4.
- If the two vertical white bars do not appear clearly, press **OK** and then **PR +** or **-** to set the unit to a vacant channel between 28 and 60 which is not occupied by any local station in your area.

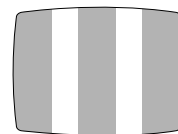

(Example) If channel 50 is available in your area

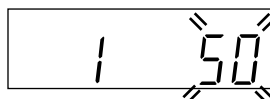

Then set your TV to UHF channel 50 and check if the two vertical white bars appear clearly on the TV screen; if so, go to step 4. If not, re-set the unit to another vacant channel and try again.

NOTES:

- If you set the unit to a channel which is occupied by a local station or has neighbouring channels that are occupied by local stations, the picture reception quality will be affected and some interference noise will appear on the TV screen. Be sure to select a vacant channel which has no broadcast on neighbouring channels.
- If you cannot obtain the two vertical white bars clearly with any channel between 28 and 60, consult your JVC dealer.

4 Exit the Video Channel Set mode.

Press **OK** on the remote control.

- If Auto Set Up (pg. 16) or Tuner Set (pg. 83) has not previously been performed, the Clock Set screen appears and Auto Set Up takes place automatically.

With AV or S-VIDEO Connection

To view picture signals from the unit, set your TV to its AV mode.

With RF Connection

The channel on which the TV screen in step 3 appears clearly is your video channel.

To view picture signals from the unit, set your TV to the video channel.

Auto Set Up

The Auto Set Up simplifies installation by guiding you through the procedures of setting the clock and tuner channels — simply follow the on-screen menus that appear.

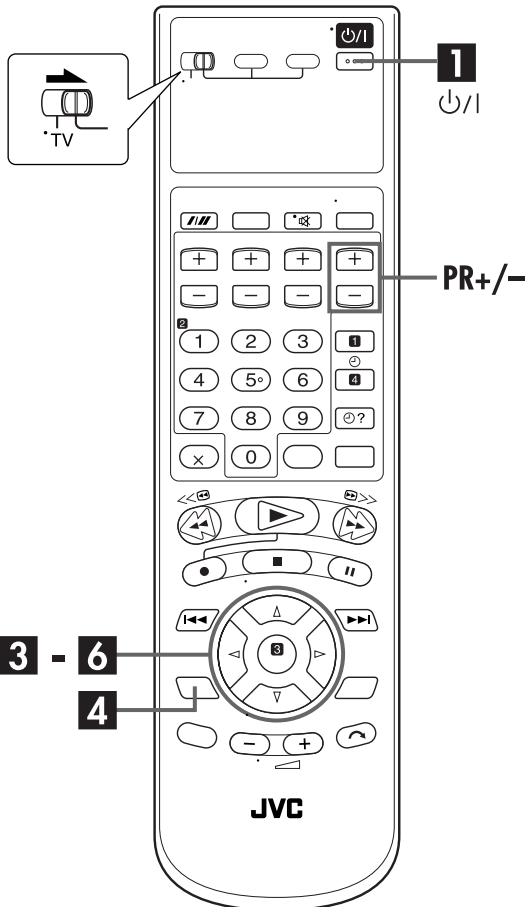

Before starting, make sure of the following:

- The TV aerial cable should be connected to the unit.
- The unit's mains power cord should be connected to a mains outlet.
- The "Video Channel Set" (pg. 15) should be performed and the TV should be set to its AV mode (with AV or S-VIDEO connection pg. 12) or UHF channel (with RF connection pg. 12).
- Slide the TV/S-VHS/DVD switch to the right.

1 Turn on the unit.

Press power on the unit or remote control. The Clock Set screen appears on the TV screen.

2 Set the time.

Press Δ / ∇ to set the hour, then press **OK** or \triangleright .

- Press and hold Δ / ∇ to change the time by 30 minutes.

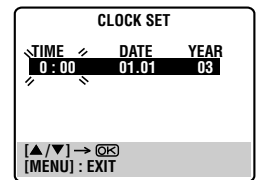

3 Set the date.

Press Δ / ∇ to set the date, then press **OK** or \triangleright .

- Press and hold Δ / ∇ to change the date by 15 days.

4 Set the year.

Press Δ / ∇ to set the year, then press **SET UP MENU**.

- Press and hold Δ / ∇ to change the year by 1 year.

5 Select the TV system.

Press Δ / ∇ to place the pointer next to the appropriate TV system (refer to the table below).

Major Countries/Areas	TV System
Australia, New Zealand, Kuwait, U.A.E., Indonesia, Singapore, Thailand, Malaysia, Iran, Saudi Arabia, Egypt, Morocco, Lebanon, Iraq	B/G
China, Mongolia, Russia	D/K
Hong Kong	I

6 Start Auto Channel Set

Press **OK** or \triangleright .

DO NOT press any button on the unit or remote control while Auto Set Up is in progress.

- Receivable channels in your area are automatically assigned to the **PR +/-** buttons, and non-receivable channels are skipped.
- As Auto Set Up progresses, the "■" mark on the TV screen moves from left to right.
- When Auto Set Up is completed, the lowest position number will appear on the front display panel. If "SCAN COMPLETED – NO SIGNAL–" is displayed on the TV screen, make sure that the aerial cable is connected to the unit properly and press **OK** on the remote control. The unit will try Auto Set Up again.

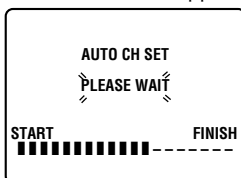

NOTES:

- If there is a power cut, or if you press ⏻ or **SET UP MENU** while Auto Set Up is in progress, Auto Set Up will be interrupted; be sure to turn off the unit power once and try again from step 1.
- If no sound accompanies the picture or the audio sounds unnatural on some channels that have been stored by Auto Set Up, the TV system setting for those channels may be incorrect. Select the appropriate TV system for those channels. (☞ pg. 86, "TV System Selection — When you see the picture but the audio can't be heard or sounds unnatural")

ATTENTION

If you perform Auto Set Up successfully during installation, there's no need to separately perform the Clock Set or Channel Set procedures, but if adjustments become necessary, they can be performed as follows:

- Tuner setting ☞ pg. 83
- Clock setting ☞ pg. 87

After "Auto Set Up" is completed, perform "Monitor Set (DVD deck)" on page 18.

Monitor Set

(DVD deck)

You can select the monitor type depending the TV used when you play back DVD VIDEO discs recorded for wide-screen TVs.

For the multi colour system TV

When you use a multi colour system TV, you can change the colour system of this unit automatically by selecting "MULTI" options as the monitor type. In this case, the setting of this unit is changed to match the colour system of the loaded disc regardless the TV system setting. (☞ "ATTENTION" below)

ATTENTION

How to change the TV system

Press and hold **■** for more than 3 seconds to change the DVD colour system between PAL and NTSC. The current colour system is displayed on the front display panel for about 3 seconds.

- Turn on the TV and select the video channel (or AV mode).
- Slide the **TV/S-VHS/DVD** switch to the right.

1 Turn on the unit.

Press **⏻/I**.

2 Select the DVD deck.

On the unit

Press **S-VHS/DVD** repeatedly so that the DVD indicator lights up.

On the remote control

Press **DVD** so that the DVD indicator lights up.

3 Access the DVD Set Up menu screen.

- 1 Press **SET UP MENU**.
- 2 Press **< >** to select "PICTURE".

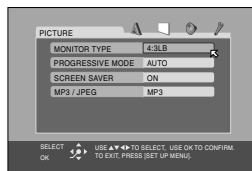

4 Select the mode.

Press **△▽** to move **↔** to "MONITOR TYPE", then press **OK**.

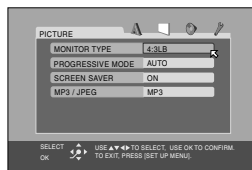

5 Select the mode setting.

Press **△▽** to select the desired setting.

6 Return to the normal screen.

Press **SET UP MENU**.

* The default setting is **bold** in the table below.

MONITOR TYPE

16:9 NORMAL / 16:9 MULTI NORMAL

(Wide television conversion):

Select this when the aspect ratio of your TV is fixed to 16:9 (wide TV). The unit automatically adjusts the screen width of the output signal correctly when playing back a picture whose aspect ratio is 4:3.

16:9 AUTO / 16:9 MULTI AUTO

(Wide television conversion):

Select this when the aspect ratio of your TV is 16:9 (wide TV).

4:3 LB / 4:3 MULTI LB (Letter Box conversion):

Select this when the aspect ratio of your TV is 4:3 (conventional TV). While viewing a wide screen picture, the black bars appear on the top and the bottom of the screen.

4:3 PS / 4:3 MULTI PS (Pan&Scan):

Select this when the aspect ratio of your TV is 4:3 (conventional TV). While viewing a wide screen picture, the black bars do not appear; however, the left and right edges of the pictures will not be shown on the screen.

Pan&Scan/Letter Box

In general, DVD VIDEO disc are produced for a wide-screen TV with 16:9 aspect ratio.

Material with this ratio will not fit to a TV with 4:3 aspect ratio. There are two styles to display the image, "Pan&Scan" (PS) and "Letter Box" (LB).

Pan&Scan

The right and left side of the image are cut off. The image fills the screen.



Letter Box

Black bands appear at the top and bottom of the image. The image itself appears in 16:9 aspect ratio.



NOTES:

- Even if "4:3 PS" or "4:3 MULTI PS" is selected, the screen size may become "4:3 LB" or "4:3 MULTI LB" with some DVD VIDEO. This depends on how they are recorded.
- When you select "16:9 NORMAL" or "16:9 MULTI NORMAL" for a picture whose aspect ratio is 4:3, the picture slightly changes due to the process for converting the picture width.

Scan Mode Set

(DVD deck)

This unit supports the progressive scan system (eg. 480p*) as well as the conventional interlaced scan system (eg. 480i*).

If your TV equipped with component video connectors supports the progressive video input, you can enjoy a high quality picture by setting the progressive scan mode to active.

- Refer also to the instruction manuals supplied with your TV.
 - If your TV equipped with component video connectors does not support the progressive video input, do not change the scan mode to the "PROGRESSIVE" or "FILM".
- * 480p and 480i indicate the number of scanning lines and scanning format of an image signal.
- 480p indicates 480 scanning lines with progressive format.
 - 480i indicates 480 scanning lines with interlaced format.

You can select the progressive mode according to the picture type (film or video source). This takes effect only when Progressive mode is selected as the scanning mode. (ATTENTION below)

ATTENTION

How to change the Scan mode

Press and hold **DVD PICTURE** for more than 3 seconds, to change the scan mode between Progressive and Interlace mode.* When DVD colour system is set to "PAL" (pg. 18), you cannot select the progressive mode.

* The Scan Mode indicator lights up as described below.

Green: in the Interlace mode
Red: in the Progressive mode

- Turn on the TV and select the video channel (or AV mode).
- Slide the **TV/S-VHS/DVD** switch to the right.

1 Turn on the unit.

Press ψ /I.

2 Select the DVD deck.

On the unit

Press **S-VHS/DVD** repeatedly so that the DVD indicator lights up.

On the remote control

Press **DVD** so that the DVD indicator lights up.

3 Access the DVD Set Up menu screen.

- 1 Press **SET UP MENU**.
- 2 Press \triangle ∇ to select "PICTURE".

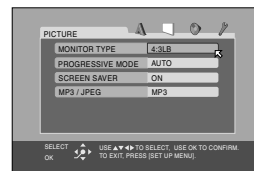

4 Select the mode.

Press \triangle ∇ to move \boxtimes to "PROGRESSIVE MODE", then press **OK**.

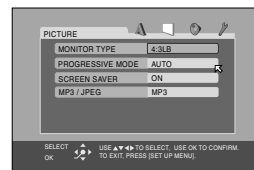

5 Select the mode setting.

Press \triangle ∇ to select the desired setting.

6 Return to the normal screen.

Press **SET UP MENU**.

* The default setting is **bold** in the table below.

PROGRESSIVE MODE

- VIDEO:** Suitable for playing back a video source disc.
- FILM:** Suitable for playing back a film or progressive source disc.
- AUTO:** Used to play a disc containing both video and film source materials. This unit recognizes the picture type (film or video source) of the current disc according to the disc information.

- If the playback picture is unclear or noisy, or the oblique lines of the picture are rough, try to change to other modes.

Language

- Turn on the TV and select the video channel (or AV mode).
- Slide the TV/S-VHS/DVD switch to the right.

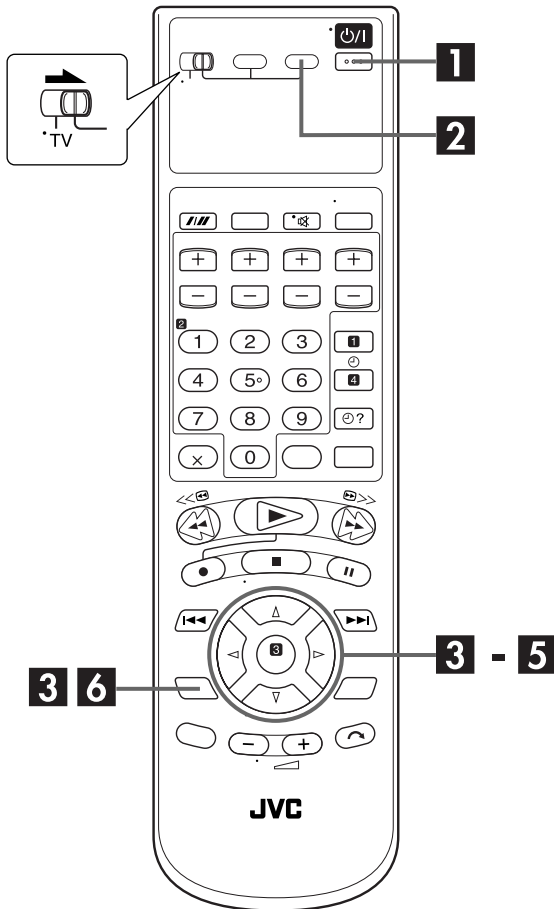

On-screen Language Set (DVD deck)

This DVD deck offers you the choice to view on-screen messages in 3 different languages. You can change the language setting manually as required.

1 Turn on the unit.

Press P/I .

2 Select the DVD deck.

On the unit

Press S-VHS/DVD repeatedly so that the DVD indicator lights up.

On the remote control

Press DVD so that the DVD indicator lights up.

3 Access the DVD Set Up menu screen.

1 Press SET UP MENU.

2 Press \triangleleft \triangleright to select "LANGUAGE".

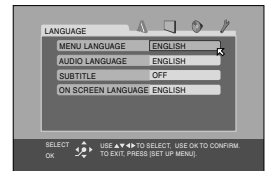

4 Select the mode.

Press \triangle ∇ to move P to "ON SCREEN LANGUAGE", then press OK.

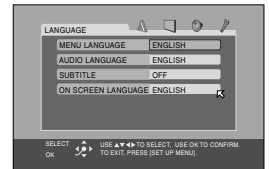

5 Select the mode setting.

Press \triangle ∇ to select the desired setting.

6 Return to the normal screen.

Press SET UP MENU.

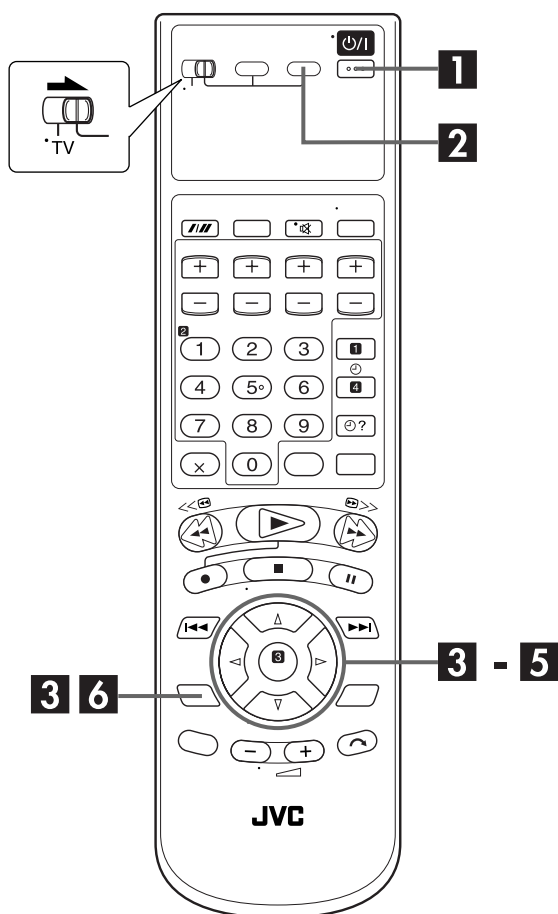

Menu/Audio/Subtitle Language Set (DVD deck only)

Some DVD discs contain the DVD menu display, audio, subtitle in the multiple languages. With these discs, you can set the default language as you like.

- The procedure shows how to set “MENU LANGUAGE” on the DVD Set Up menu screen as an example.

1 Turn on the unit.

Press P/I .

2 Select the DVD deck.

On the unit

Press **S-VHS/DVD** repeatedly so that the DVD indicator lights up.

On the remote control

Press **DVD** so that the DVD indicator lights up.

3 Access the DVD Set Up menu screen.

- 1 Press **SET UP MENU**.
- 2 Press $\triangleleft \triangleright$ to select “**LANGUAGE**”.

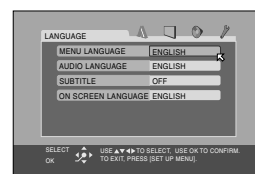

4 Select the mode.

Press $\triangle \nabla$ to move P to “**MENU LANGUAGE**”, then press **OK**.

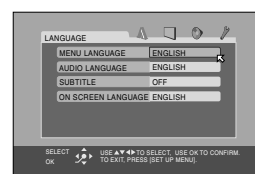

5 Select the mode setting.

Press $\triangle \nabla$ to select the desired setting.

- See “Language Code List” (pg. 22).

6 Return to the normal screen.

Press **SET UP MENU**.

NOTE:

When the selected language is not available on the disc, the disc’s default menu language is played back.

Language Code List

AA	Afar
AB	Abkhazian
AF	Afrikaans
AM	Ameharic
AR	Arabic
AS	Assamese
AY	Aymara
AZ	Azerbaijani
BA	Bashkir
BE	Byelorussian
BG	Bulgarian
BH	Bihari
BI	Bislama
BN	Bengali, Bangla
BO	Tibetan
BR	Breton
CA	Catalan
CO	Corsican
CS	Czech
CY	Welsh
DA	Danish
DZ	Bhutani
EL	Greek
EO	Esperanto
ET	Estonian
EU	Basque
FA	Persian
FI	Finnish
FJ	Fiji
FO	Faroese
FY	Frisian
GA	Irish
GD	Scots Gaelic
GL	Galician
GN	Guarani
GU	Gujarati
HA	Hausa
HI	Hindi
HR	Croatian
HU	Hungarian
HY	Armenian
IA	Interlingua
IE	Interlingue

IK	Inupiak
IN	Indonesian
IS	Icelandic
IW	Hebrew
JL	Yiddish
JW	Javanese
KA	Georgian
KK	Kazakh
KL	Greenlandic
KM	Cambodian
KN	Kannada
KO	Korean (KOR)
KS	Kashmiri
KU	Kurdish
KY	Kirghiz
LA	Latin
LN	Lingala
LO	Laothian
LT	Lithuanian
LV	Latvian, Lettish
MG	Malagasy
MI	Maori
MK	Macedonian
ML	Malayalam
MN	Mongolian
MO	Moldavian
MR	Marathi
MS	Malay (MAY)
MT	Maltese
MY	Burmese
NA	Nauru
NE	Nepali
NL	Dutch
NO	Norwegian
OC	Occitan
OM	(Afan) Oromo
OR	Oriya
PA	Panjabi
PL	Polish
PS	Pashto, Pushto
PT	Portuguese
QU	Quechua
RM	Rhaeto-Romance

RN	Kirundi
RO	Rumanian
RU	Russian
RW	Kinyarwanda
SA	Sanskrit
SD	Sindhi
SG	Sangho
SH	Serbo-Croatian
SI	Singhalese
SK	Slovak
SL	Slovenian
SM	Samoa
SN	Shona
SO	Somali
SQ	Albanian
SR	Serbian
SS	Siswati
ST	Sesotho
SU	Sundanese
SV	Swedish
SW	Swahili
TA	Tamil
TE	Telugu
TG	Tajik
TH	Thai
TI	Tigrinya
TK	Turkmen
TL	Tagalog
TN	Setswana
TO	Tonga
TR	Turkish
TS	Tsonga
TT	Tatar
TW	Twi
UK	Ukrainian
UR	Urdu
UZ	Uzbek
VI	Vietnamese
VO	Volapuk
WO	Wolof
XH	Xhosa
YO	Yoruba
ZU	Zulu

Basic Playback

- Turn on the TV and select the video channel (or AV mode).
- Slide the TV/S-VHS/DVD switch to the right.

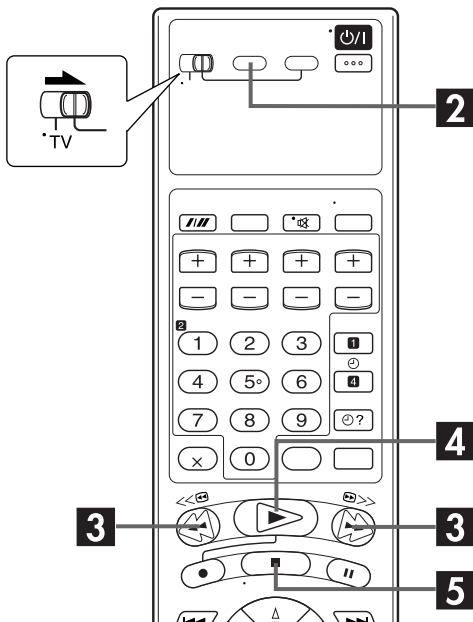
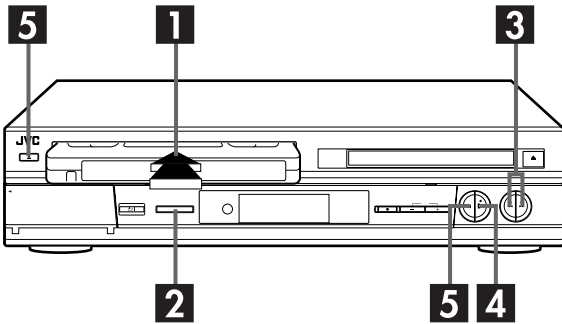

Clean the video heads using a dry cleaning cassette — ECL-3F — when:

- Rough, poor picture appears while a tape is played back.
- The picture is unclear or no picture appears.
- "USE CLEANING CASSETTE" appears on the screen (only with "O.S.D." set to "ON"). (☞ pg. 78)

NOTE:

The heads get dirty in the following cases:

- in an environment prone to extreme temperature or humidity
- in a dusty environment
- flaw, dirt or mold on video tapes
- continuous usage for a long time

1 Load a cassette.

Make sure the window side is up, the rear label side is facing you and the arrow on the front of the cassette is pointed toward the unit.

- Do not apply too much pressure when inserting.
- If the record safety tab has been removed, playback begins automatically.
- The unit's power comes on automatically and the counter is reset to 0:00:00.

2 Select the S-VHS deck.

On the unit

Press S-VHS/DVD repeatedly so that the S-VHS indicator lights up.

On the remote control

Press S-VHS so that the S-VHS indicator lights up.

3 Find the programme start point.

If the tape is advanced past the start point, press ◀◀. To go forward, press ▶▶.

4 Start playback.

Press ▶. "bEST" appears blinking on the front display panel during automatic tracking. (☞ pg. 30)

5 Stop playback.

Press ■. Then press ▲ on the S-VHS deck to remove the cassette.

NOTE:

S-VHS playback is possible only with S-VHS PAL tapes recorded in SP or LP mode, or S-VHS NTSC tapes recorded in the SP mode.

Usable cassettes

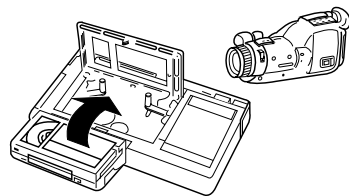

- Compact VHS camcorder recordings can be played on this unit. Simply place the recorded cassette into a VHS Cassette Adapter and it can be used just like any full-sized VHS cassette.
- This unit can record on regular VHS and Super VHS cassettes. While only VHS signals can be recorded on regular VHS cassettes*, both VHS and Super VHS signals can be recorded and played back using Super VHS cassettes.

* By using the S-VHS ET function, it is possible to record and play back with S-VHS picture quality on VHS cassettes with this unit.

Playback Features

- Turn on the TV and select the video channel (or AV mode).
- Slide the TV/S-VHS/DVD switch to the right.

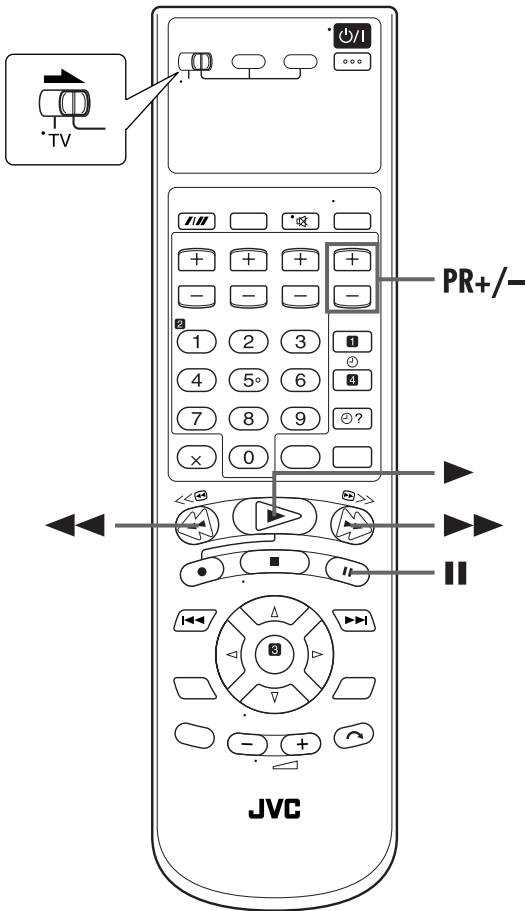

Still Picture/Frame-By-Frame Playback

1 Pause during playback.

Press **II**.

- If there is vertical jitter, press **PR +/-** on the remote control to correct the picture.

2 Activate frame-by-frame playback.

Press **II**.

Slow Motion

During still picture, press and hold **II** for 2 seconds, then release. Press **II** and release again to return to still picture.

NOTE:

During slow motion playback, some noise may appear on the TV screen. Press **PR +** or **-** on the remote control to eliminate the noises.

High-Speed (Turbo) Search

During playback, press **▶▶** for forward high-speed search, or **◀◀** for reverse high-speed search.

To resume normal playback, press **▶**.

ATTENTION

In the search, still, slow-motion or frame-by-frame playback mode,

- the picture will be distorted.
- the noise bars will appear.
- there may be a loss of colour.

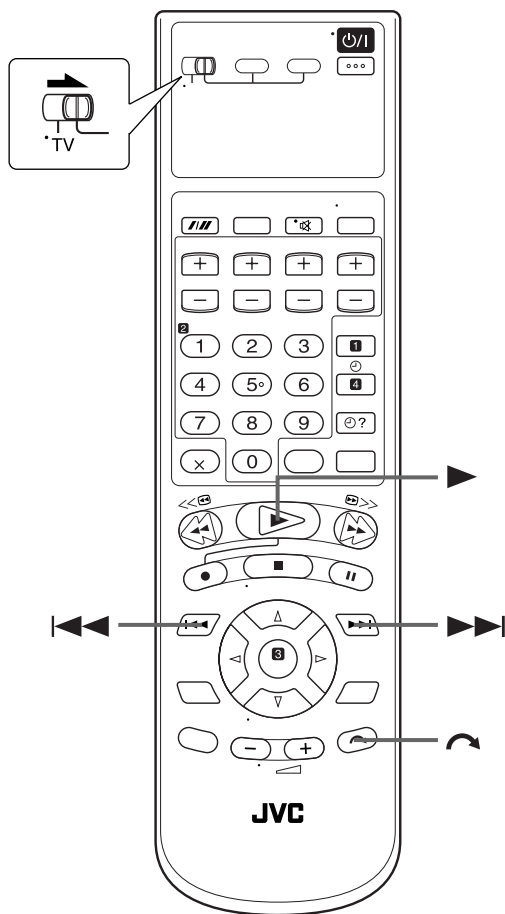

Index Search

Your unit automatically marks index codes at the beginning of each recording. This function gives you quick access to any one of 9 index codes in either direction.

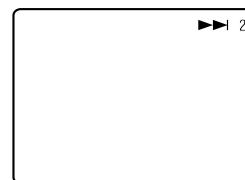

NOTE:

Before starting, make sure the unit is in the Stop mode.

Activate Index Search.

Press \lll or \ggg . " $\lll 1$ " or " $\ggg 1$ " is displayed on the TV screen and search begins in the corresponding direction.

- To access index codes 2 through 9, press \lll or \ggg repeatedly until the correct index number is displayed.

Example:

To locate the beginning of B from the current position, press \lll twice.

To locate the beginning of D from the current position, press \ggg once.

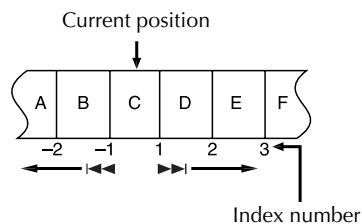

- When the specified index code is located, playback begins automatically.

Skip Search

During playback, press \curvearrowright 1 to 4 times to skip over unwanted sections.

Each press initiates a 30-second period of fast-motion playback. Normal playback resumes automatically.

To resume normal playback during a Skip Search, press \blacktriangleright .

Next Function Memory

The Next Function Memory "tells" the unit what to do after rewinding. Before continuing, make sure the unit is in the Stop mode.

- a- For Automatic Start Of Playback
Press ◀◀, then press ▶ within 2 seconds.
- b- For Automatic Power Off
Press ◀◀, then press ⏻ within 2 seconds.
- c- For Automatic Timer Standby
Press ◀◀, then press ⊕ (TIMER) within 2 seconds.
- d- For Automatic Cassette Ejection After Tape Rewind
Press ◀◀, then press ▲ within 2 seconds.

Repeat Playback

Your unit can automatically play back the whole tape 100 times repeatedly.

1 Start playback.

Press ▶.

2 Activate Repeat Playback.

Press ▶ and hold for over 5 seconds, then release.

- The Play indicator (▷) on the front display panel blinks slowly.
- After playing back a tape 100 times, the unit stops automatically.

3 Stop Repeat Playback.

Press ■ at any time.

- Pressing ▶, ◀◀, ▶▶ or || also stops Repeat Playback.

NOTE:

Repeat playback is not possible with a cassette recorded in EP mode.

Manual Tracking

Your unit is equipped with automatic tracking control. During playback, you can override this and adjust the tracking manually by pressing the **PR** buttons.

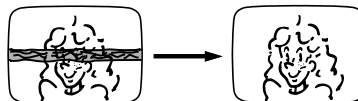

1 Override automatic tracking.

During playback, press **PR** on the remote control.

2 Adjust the tracking manually.

Press **PR +** or **-** on the remote control.

- Press **PR** again to return to automatic tracking.

NOTE:

When a new tape is inserted, the unit enters the automatic tracking mode automatically.

Soundtrack Selection

Your unit is capable of recording three soundtracks (HI-FI L, HI-FI R and NORM) and will play back the one you select.

During Playback

Pressing **A.MONITOR** changes the soundtrack as follows:

TRACK	USE
On-Screen Display	
HI FI L ▶ ▶ R	For Hi-Fi stereo tapes
HI FI L ▶	For main audio of Bilingual tapes
HI FI ▶ ▶ R	For sub audio of Bilingual tapes
NORM	For audio-dubbed tapes
HI FI NORM	For audio-dubbed tapes

NOTES:

- "HI FI L ▶ ▶ R" should normally be selected. In this mode, Hi-Fi stereo tapes are played back in stereo, and the normal audio track is played back automatically for tapes with only normal audio.
- For instructions on recording stereo and bilingual programmes, refer to page 29.
- "O.S.D." must be set to "ON" or the on-screen displays will not appear. (☞ pg. 78)

Basic Recording

- Turn on the TV and select the video channel (or AV mode).
- Slide the TV/S-VHS/DVD switch to the right.

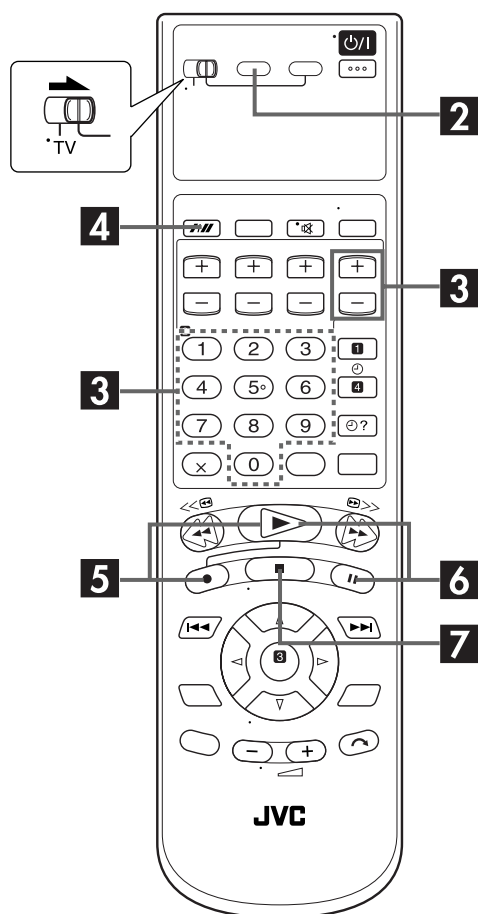
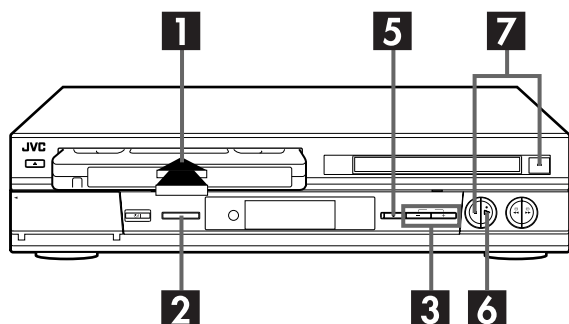

1 Load a cassette.

Insert a cassette with the record safety tab intact.

- The unit's power comes on automatically and the counter is reset to 0:00:00.

2 Select the S-VHS deck.

On the unit

Press **S-VHS/DVD** repeatedly so that the S-VHS indicator lights up.

On the remote control

Press **S-VHS** so that the S-VHS indicator lights up.

3 Choose a programme.

Press **PR +/-** or the **number keys** to select the channel you wish to record.

4 Set the tape speed.

Press **SP/LP/EP (//)**. The current setting appears on the front display panel or TV screen. Press **SP/LP/EP (//)** again to change the setting while the tape speed is displayed on the TV screen.

- Select the appropriate colour system with "PAL/MESECAM" and "NTSC". (☞ pg. 77, 78)

5 Start recording.

Press and hold **●** and press **▶** on the remote control, or press **●** on the unit.

B.E.S.T. takes place at the beginning of both the first SP and the first LP (or EP) recording after inserting the cassette. (☞ pg. 30)

6 Pause/Resume recording.

Press **II**. Press **▶** to resume recording.

- You can select channel during the Record Pause mode.

7 Stop recording.

Press **■**. Then press **▲** on the S-VHS deck to remove the cassette.

NOTES:

- S-VHS recording is possible only for PAL signals recorded in the SP or LP mode, or NTSC signals recorded in the SP mode. S-VHS recording is impossible for NTSC4.43 signals.
- S-VHS ET recording is possible only for PAL signals recorded in the SP mode, or NTSC signals recorded in the SP mode.
- When recording in NTSC, if EP is selected, recording will always be done in the VHS mode even if an S-VHS cassette is used.

Recording Features

- Turn on the TV and select the video channel (or AV mode).
- Slide the TV/S-VHS/DVD switch to the right.

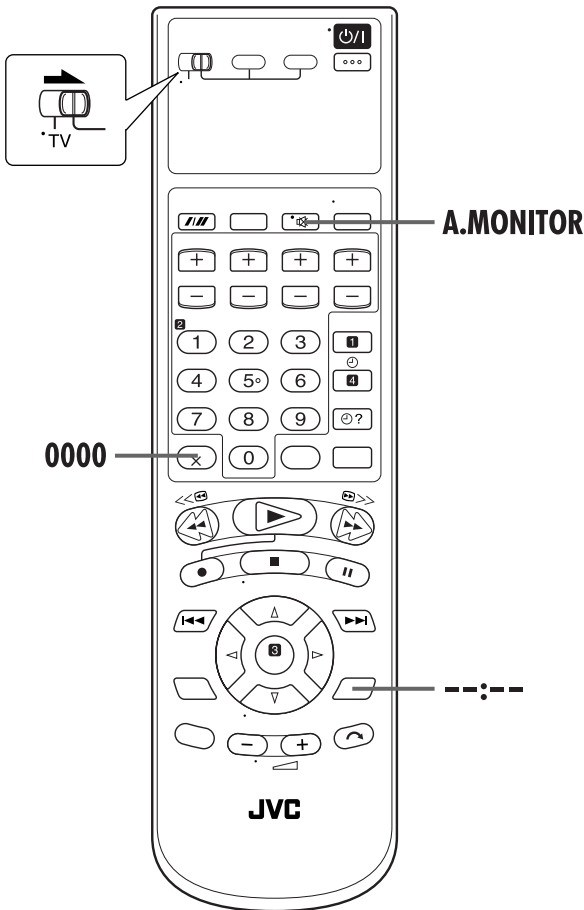
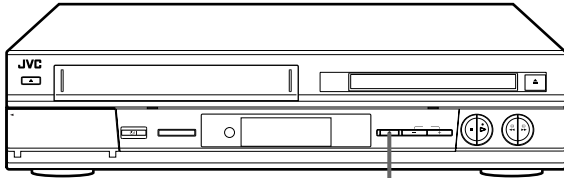

Record One Programme While Watching Another

Once recording is in progress, all you need to do is to set the channel controls on the TV for the station you wish to view.

- The programme selected with the TV's channel controls appears on the TV screen, while the one selected with the unit's **PR** buttons is recorded on the tape.

Instant Timer Recording (ITR)

This easy method lets you record for from 30 minutes to 6 hours (selectable in 30-min. increments), and shuts the unit off after recording is finished.

1 Start recording.

Press ● on the unit.

2 Engage the ITR mode.

Press ● again. "○" blinks and "0:30" appears on the front display panel.

3 Set the recording duration.

If you want to record for more than 30 minutes, press ● to extend the time. Each press extends recording time by 30 minutes.

NOTE:

You can only perform ITR using the ● button on the unit's front panel.

Accidental erasure prevention

To prevent accidental recording on a recorded cassette, remove its safety tab. To record on it later, cover the hole with adhesive tape.

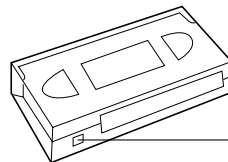

Record safety tab

Elapsed Recording Time Indication

1 Set the counter display.

Press **--:--** until a counter reading appears on the front display panel.

- The front display panel shows the counter reading with “:” lit.

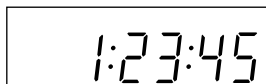

2 Reset the counter.

Press **0000** before starting recording or playback.

- The counter is reset to “0:00:00” and shows the exact elapsed time as the tape runs. You can check the exact time of a recording or playback.

Tape Remaining Time

Press **--:--** until the time remaining on the tape appears.

- The front display panel shows the tape remaining time with “:” blinking.



- By pressing the **--:--** button, you can change display to show the channel position*, clock time, counter reading or tape remaining time.

* Channel position is not displayed during playback.

NOTE:

Depending on the type of tape being used, the tape remaining time reading may not appear right away, or is not correct. “--:--” may sometimes appear, or the display may blink on occasion.

Receiving Stereo and Bilingual Programmes

Your unit is equipped with a Sound-Multiplex decoder (A2) and a Digital stereo sound decoder (NICAM) making reception of stereo and bilingual broadcasts possible.

When the channel is changed, the type of broadcast being received will be displayed on the TV screen for a few seconds.

Type of Broadcast Being Received	On-screen Display
A2 Stereo	ST
A2 Bilingual	BIL.
Regular Monaural	(none)
NICAM Stereo	ST NICAM
NICAM Bilingual	BIL. NICAM
NICAM Monaural	NICAM

- To listen to a stereo programme, press **A.MONITOR** until “HIFI L R” appears on the TV screen.
- To listen to a bilingual programme, press **A.MONITOR** until “HIFI L R” or “HIFI R” appears on the TV screen.
- To listen to the standard (Regular Monaural) audio while receiving a NICAM broadcast, press **A.MONITOR** until “NORM” appears on the TV screen.

NOTE:

“O.S.D.” must be set to “ON”, or the on-screen displays will not appear. (pg. 78)

To Record Stereo and Bilingual Programmes (A2)

Stereo programmes are automatically recorded in stereo on the Hi-Fi audio track (with the normal audio track recording mixed L and R channel sound).

- Bilingual programmes are automatically recorded in bilingual on the Hi-Fi audio track. The main soundtrack will be recorded on the normal audio track.

To Record NICAM Stereo and Bilingual Programmes

The NICAM audio programme will be recorded on the Hi-Fi audio track, and the standard audio programme will be recorded on the normal audio track.

NOTES:

- If the quality of stereo sound being received is poor, the broadcast will be received in monaural with better quality.
- Before playing back a programme recorded in stereo, or a bilingual programme, refer to “Soundtrack Selection” on page 26.

B.E.S.T. Picture System

The B.E.S.T. (Biconditional Equalised Signal Tracking) system checks the condition of the tape in use during playback and recording, and compensates to provide the highest-possible playback and recording pictures. You can set "B.E.S.T." to "ON" or "OFF" to your preference. (☞ pg. 77)

Playback

The unit assesses the quality of the tape once you initiate playback.

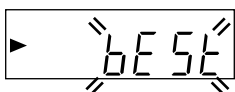

- The unit adjusts the playback picture quality based on the quality of the tape in use.
- B.E.S.T. is active during automatic tracking. "bEST" appears blinking on the front display panel.

NOTES:

- When watching a tape recorded with "B.E.S.T." set to "ON", it is recommended that you leave B.E.S.T. on during playback as well.
- When watching a rental tape or one recorded on another video recorder, or when using this unit as the player for editing, set B.E.S.T. to your preference. (☞ pg. 77)
- "bEST" only appears at the beginning of automatic tracking. Even though it doesn't appear after that, the B.E.S.T. function is operative.

Recording

The unit assesses the quality of the tape once you initiate recording.

DURING B.E.S.T.

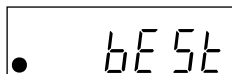

B.E.S.T. COMPLETE

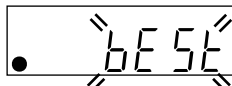

- The unit spends approximately 7 seconds assessing the condition of the tape, then begins recording.

NOTES:

- The B.E.S.T. system works for both SP and LP (or EP) modes only after a tape has been inserted and the Record mode is first initiated. It does not work during recording.
- The B.E.S.T. system does not work while Automatic Satellite Programme Recording is in progress. (☞ pg. 39)
- In the case of timer recordings, the B.E.S.T. system works before recording is initiated.
- Once the cassette is ejected, the B.E.S.T. data is cancelled. The next time the cassette is used for recording, B.E.S.T. is re-performed.
- Pressing the unit's ● button while "bEST" is displayed does not start Instant Timer Recording. (☞ pg. 28)

ATTENTION

Since the B.E.S.T. system works before recording actually starts, there is a delay of approximately 7 seconds after ● and ► on the remote control are pressed, or ● on the unit is pressed. To make sure you record the desired scene or programme in its entirety, first perform the following steps:

① Press and hold ■ and press ● to engage the Record Pause mode.

- The unit then automatically checks the condition of the tape and, after approximately 7 seconds, re-enters Record Pause mode.

② Press ► to start recording.

If you want to bypass the B.E.S.T. system and begin recording immediately, set "B.E.S.T." to "OFF". (☞ pg. 77)

G-CODE™/SHOWVIEW™ System Setup

The G-CODE timer programming system eliminates the need to input channel, date, start and stop time data when setting the timer record function. Simply key in the G-CODE number for the TV programme you wish to record (found in most TV listings) and the unit's timer is automatically programmed.

You have to set Guide Program numbers, which are assigned to each station for purposes of SHOWVIEW timer programming, for all the stations stored in your unit's memory to get proper results.

Before G-CODE setup you must have performed Auto Set Up (☞ pg. 16).

IMPORTANT

After setting the Guide Program Numbers, channel positions may be incorrect if you stored or skipped channels. In this case, re-perform Guide Program Number setting.

INFORMATION

G-CODE and SHOWVIEW are different trademarks used to represent the same easy recording feature, but only the term G-CODE system will be used in the instructions. If you use the SHOWVIEW system, follow the same instructions listed for the G-CODE system.

Turn on the TV and select the video channel (or AV mode).

Guide Program Number Set

1 Access the Main Menu screen.

Press **SET UP MENU**.

2 Access the Initial Set screen.

Press Δ / ∇ to move the highlight bar (pointer) to "INITIAL SET", then press **OK** or \triangleright .

3 Access the Guide Program Set screen.

Press Δ / ∇ to move the highlight bar (pointer) to "G-CODE/SHOWVIEW SETUP", then press **OK** or \triangleright .

4 Enter the Guide Program number.

Press Δ / ∇ or **number keys** to enter the Guide Program number for the desired station as shown in the TV listings. Then press **OK** or \triangleright .

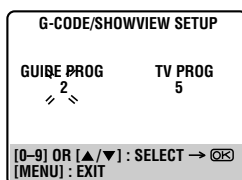

(Example) When inputting the Guide Program number 2 for RTR.

5 Enter the receiving channel position number.

Then press Δ / ∇ or **number keys** to input the number of the unit's channel position on which the Guide Program number's broadcast is received by the unit. Then press **OK** or \triangleright .

- If the satellite broadcast is received on your unit's auxiliary channel "L-1", select "L-1" for the channel position.
- Repeat steps 4 and 5 as necessary.

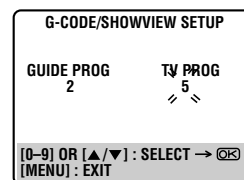

(Example) If RTR is received on channel position 2.

6 Return to the normal screen.

Press **SET UP MENU**.

Guide Program Number

"Guide Program (GUIDE PROG) number" refers to the assigned TV station numbers, according to broadcast area, for the G-CODE timer recording. The Guide Program numbers can be found in most TV listings.

G-CODE™ / SHOWVIEW™ Timer Programming

With the G-CODE/SHOWVIEW system, timer programming is greatly simplified because each TV programme has a corresponding code number which your unit is able to recognize.

INFORMATION

G-CODE and SHOWVIEW are different trademarks used to represent the same easy recording feature, but only the term G-CODE system will be used in the instructions. If you use the SHOWVIEW system, follow the same instructions listed for the G-CODE system.

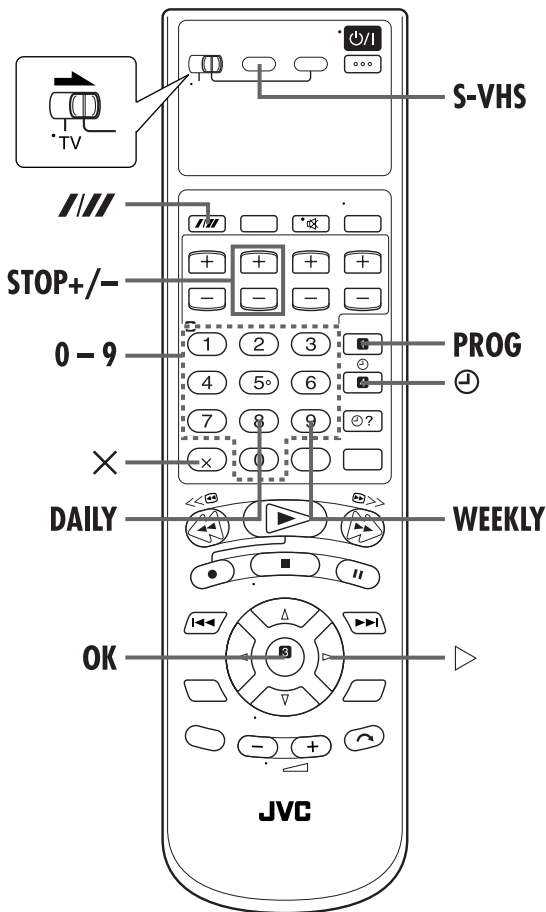

Before performing the G-CODE™/SHOWVIEW™ Timer Programming:

- Be sure to read "G-CODE™/SHOWVIEW™ System Setup" (pg. 31).
- Make sure that the unit's built-in clock is set properly.
- Insert a cassette with the safety tab in place. The unit will come on automatically.
- Turn on the TV and select the video channel (or AV mode).
- Slide the TV/S-VHS/DVD switch to the right.

1 Select the S-VHS deck.

On the unit

Press **S-VHS/DVD** repeatedly so that the S-VHS indicator lights up.

On the remote control

Press **S-VHS** so that the S-VHS indicator lights up.

2 Access the G-CODE/SHOWVIEW screen.

Press **PROG.**

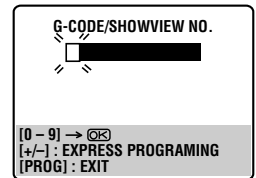

3 Enter the G-CODE number.

Press the **number keys** to enter the G-CODE number of a programme you wish to record.

- If you make a mistake, press **X** and input the correct number.



4 Access the G-CODE Program screen.

Press **OK**, then the G-CODE Program screen appears (if you're just starting out, "P1" appears).

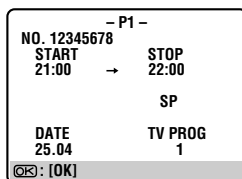

IMPORTANT

Make sure the channel position number you wish to record is displayed; if not, see "G-CODE™/SHOWVIEW™ System Setup" on page 31 and set the Guide Program number correctly.

- If the number you entered is invalid, "ERROR" appears on the TV screen. Press **X** and input a valid G-CODE number.
- If the "G-CODE/SHOWVIEW SETUP" screen appears, see "ATTENTION" on page 33.

5 Set the tape speed.

Press **SP/LP/EP (///)**.

- Select the appropriate colour system with "PAL/MESECAM" and "NTSC". (☞ pg. 77, 78)

6 Return to the normal screen.

Press **PROG** or **OK**. "PROGRAM COMPLETED" appears on the TV screen for about 5 seconds, then the normal screen appears. If "PROGRAM OVERLAPPED" appears on the TV screen, see page 38.

- Repeat steps **2** – **3** for each additional programme.

7 Engage the unit's timer mode.

Press **⊖ (TIMER)**. The unit turns off automatically and "⊖" appears on the front display panel.

- To disengage the timer mode, press **⊖ (TIMER)** again.

NOTES:

- To Change The Stop Time:
 - press **STOP +/-** after pressing **OK** in step **4**. You can compensate for anticipated programme schedule delays.
- To Timer-Record Weekly Or Daily Serials:
 - after pressing **OK** in step **4**, press **WEEKLY (number key "9")** for weekly serials or **DAILY (number key "8")** for daily serials (Monday — Friday). Either "WEEKLY" or "DAILY" appears on the TV screen. Pressing the button again makes the corresponding indication disappear.
- You can programme this unit to timer-record as many as 8 programmes. If you try to programme the unit to record a ninth, "PROGRAM FULL" appears on the TV screen. To record the extra programme, you must first cancel any unnecessary programmes. (☞ pg. 37)

Satellite Receiver Users

To timer-record a satellite broadcast using the G-CODE/SHOWVIEW system:

- 1 Perform steps **1** – **7**.
- 2 Set the satellite receiver to the appropriate channel before the selected programme begins.
- 3 Leave the satellite receiver's power on.

ATTENTION

Guide Program Number Set

"G-CODE/SHOWVIEW SETUP" appears after performing step **4** if the Guide Program number for the G-CODE number you entered has not been set.

Press **△▽** or the **number keys** to input the channel position number on which your unit receives that station, then press **OK** or **▷** to set the Guide Program number. The G-CODE Program screen appears.

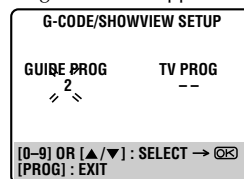

(Example)

To timer-record a RTR programme with the G-CODE system.

* If your unit receives RTR on the channel position 2, press **OK** or **▷** after entering "2".

Express Timer Programming

If you do not know the G-CODE number for the programme you wish to record, use the following procedure to set your unit to timer-record the programme.

Before performing Express Timer Programming:

- Make sure that the unit's built-in clock is set properly.
- Insert a cassette with the safety tab in place. The unit will come on automatically.
- Turn on the TV and select the video channel (or AV mode).
- Slide the TV/S-VHS/DVD switch to the right.

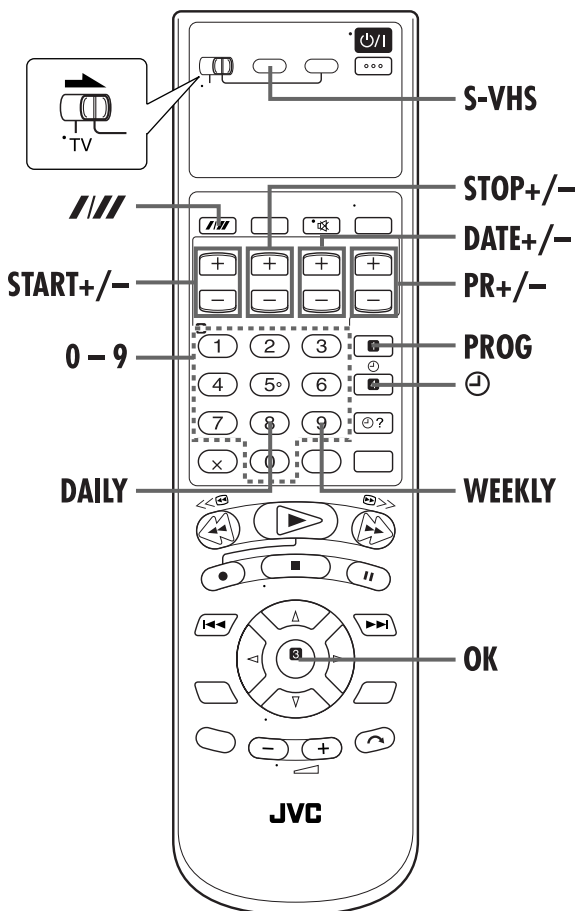

Example: To timer-record the programme from 21:00 to 22:00 on 25th December, on channel 1.

1 Select the S-VHS deck.

On the unit

Press **S-VHS/DVD** repeatedly so that the S-VHS indicator lights up.

On the remote control

Press **S-VHS** so that the S-VHS indicator lights up.

2 Access the G-CODE/SHOWVIEW screen.

Press **PROG**.

3 Access the Programme screen.

Press **START +/-**. (If you're just starting out, "P1" appears.)

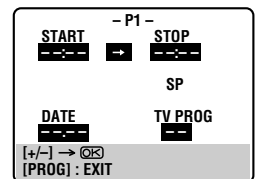

4 Enter the programme start time.

Press **START +/-** to enter the time you want recording to start.

- Press and hold **START +/-** to move in 30-minute increments, or press and release repeatedly to move 1 minute at a time.

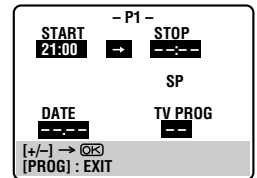

5 Enter the programme stop time.

Press **STOP +/-** to enter the time you want recording to stop.

- Press and hold **STOP +/-** to move in 30-minute increments, or press and release repeatedly to move 1 minute at a time.

6 Enter the programme date.

Press **DATE +/-**.

- The current date appears on the TV screen. The date you enter appears in its place.

7 Enter the channel position.

Press **PR +/-**.

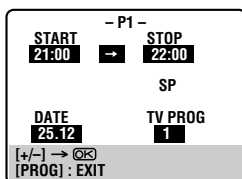

8 Set the tape speed.

Press **SP/LP/EP (///)**.

- Select the appropriate colour system with “PAL/MESECAM” and “NTSC”. (☞ pg. 77, 78)

9 Return to the normal screen.

Press **PROG** or **OK**. “PROGRAM COMPLETED” appears on the TV screen for about 5 seconds, then the normal screen appears. If “PROGRAM OVERLAPPED” appears on the TV screen, see page 38.

- Repeat steps **2** – **9** for each additional programme.

10 Engage the unit's timer mode.

Press **⊖ (TIMER)**. The unit turns off automatically and “⊖” appears on the front display panel.

- To disengage the timer mode, press **⊖ (TIMER)** again.

To Timer-Record Weekly Or Daily Serials:

— anytime during steps **4** through **8**, press **WEEKLY** (number key “9”) for weekly serials or **DAILY** (number key “8”) for daily serials (Monday – Friday). Either “WEEKLY” or “DAILY” appears on the TV screen. Pressing the button again makes the corresponding indication disappear.

NOTE:

You can programme this unit to timer-record as many as 8 programmes. If you try to programme the unit to record a ninth, “PROGRAM FULL” appears on the TV screen. To record the extra programme, you must first cancel any unnecessary programmes. (☞ pg. 37)

Satellite Receiver Users

To timer-record a satellite broadcast using Express Timer Programming:

- 1 Perform steps **1** – **10**. Enter “L-1” for the channel position in step **7**.
- 2 Set the satellite receiver to the appropriate channel before the selected programme begins.
- 3 Leave the satellite receiver's power on.

Check, cancel and change programmes

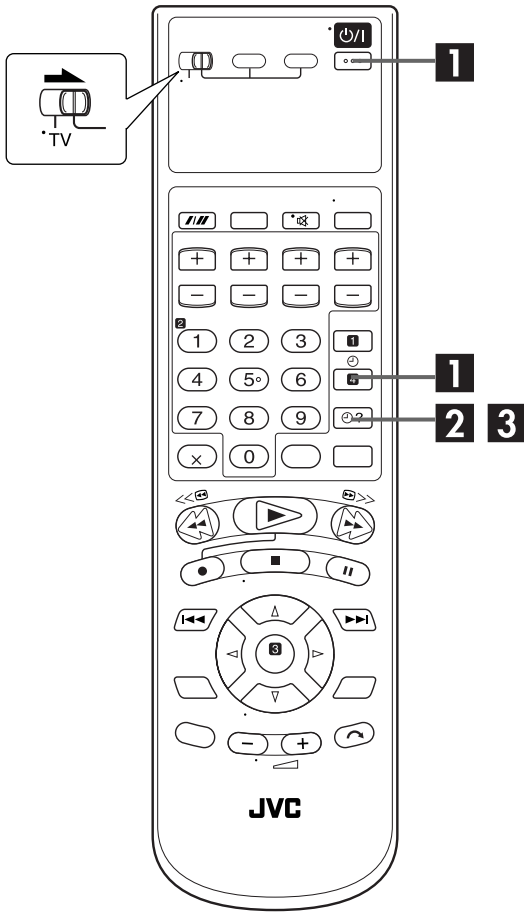

1 Disengage the timer mode.

Press **TIMER**, then press **⏻/I**.

2 Access the Programme Check screen.

Press **⊖ ?**.

PR	START	STOP	CH	DATE
1	21:00	22:00	1	25.12
2	10:00	10:45	2	25.04
3	11:30	13:00	1	25.04
4				
5				
6				
7				
8				

[⊖ ?] : NEXT

3 Access the Programme screen.

Press **⊖ ?** again to check more information. Each time you press **⊖ ?**, the next programme's information appears.

START	- P1 -	STOP
21:00	→	22:00
		SP
DATE		TV PROG
25.12		1

[⊖ ?] : NEXT

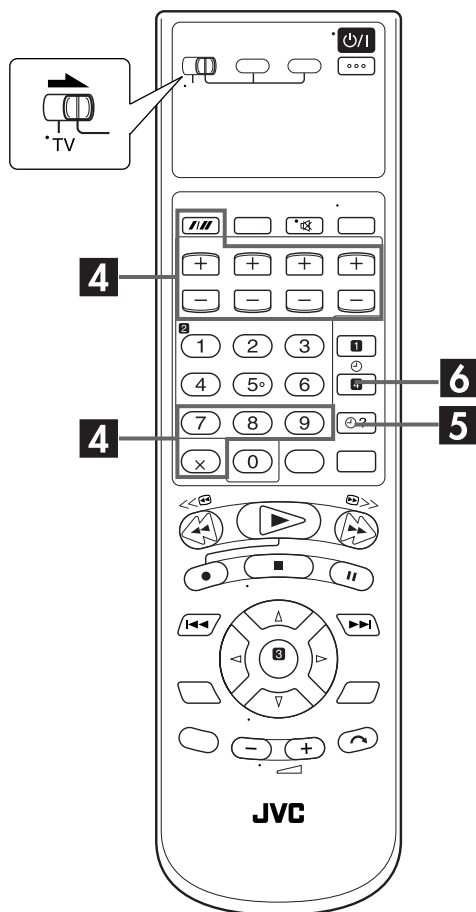

To cancel or change a programme

4 Cancel or change a programme.

Press **X** to cancel a programme. To change programme settings, press the appropriate button: **START +/-**, **STOP +/-**, **DATE +/-**, **PR +/-**, **DAILY** (number key "8"), **WEEKLY** (number key "9") and/or **SP/LP/EP** (///).

5 Return to the normal screen.

Press **⊖ ?** as many times as necessary. If there are still some programmes remaining, go on to step **6**.

6 Return to the timer mode.

Press **⊖ (TIMER)**.

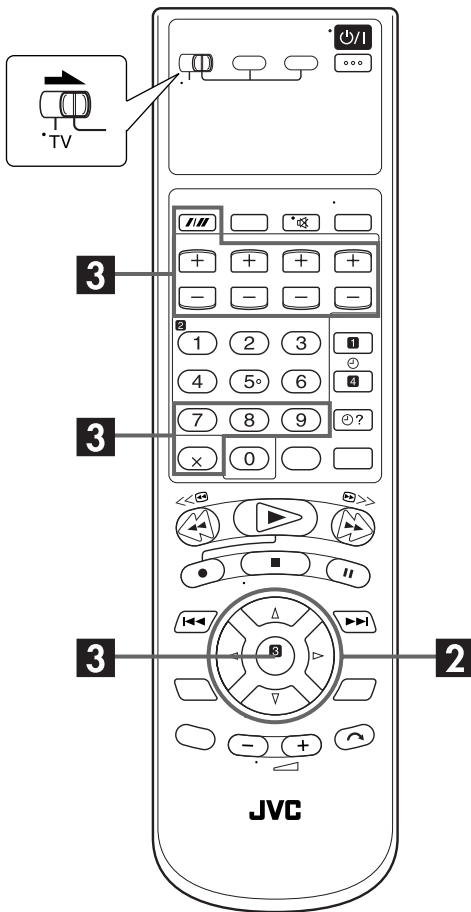

When programmes overlap each other

If "PROGRAM OVERLAPPED" appears, you have another programme overlapping the programme you have just made. The Programme Check screen appears and conflicting programmes will start blinking.

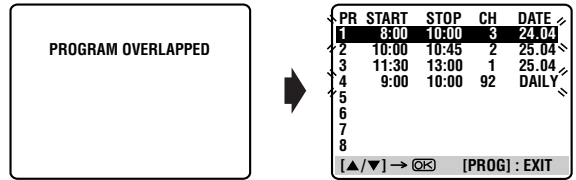

Example: Programme 1 (you have just made) and Programme 4 overlap each other.

1 Confirm the overlapping programmes.

Overlapping programmes blink on the TV screen.

2 Select the programme to modify.

Press Δ / ∇ , then press **OK** or \triangleright .

- You can only select one of the overlapping programmes.

NOTE:

If you do not mind this overlap, press **PROG** to finish the timer programme setting. The programme with the lower programme number will be recorded and the other one will not be recorded correctly. If no changes are made for approximately 1 minute, the unit will return to the normal screen.

3 Cancel or change programme setting.

To cancel a programme, press **X** when the Programme screen you do not want is shown. "PROGRAM COMPLETED" appears on the TV screen for about 5 seconds, then the normal screen appears.

To change a programme, press the appropriate button: **START +/-**, **STOP +/-**, **DATE +/-**, **PR +/-**, **DAILY** (number key "8"), **WEEKLY** (number key "9") and/or **SP/LP/EP** (///) when the Programme screen on which you want to make changes is shown, then press **OK**. "PROGRAM COMPLETED" appears on the TV screen for about 5 seconds, then the normal screen appears.

NOTE:

If the overlap is not yet solved, or another overlap occurs with the timer programme setting after making the last correction on a programme, the conflicting programmes will be shown on the Programme Check screen again. Repeat the above steps again until the overlap is solved.

Automatic Satellite Programme Recording

This function allows you to automatically record a satellite programme which is timer-programmed on your external satellite receiver. Connect a satellite receiver to the unit's AUDIO/VIDEO IN (L-1) connector and programme the timer on the satellite receiver. The unit starts or stops recording by the signals input from the satellite receiver. After recording, the unit's power shuts off automatically.

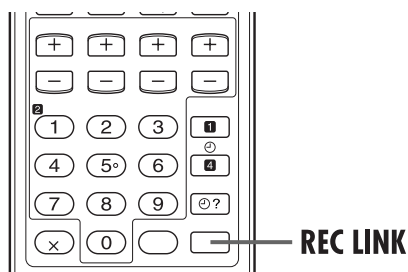
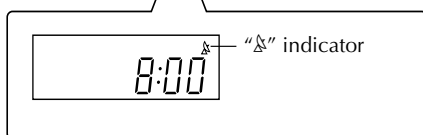
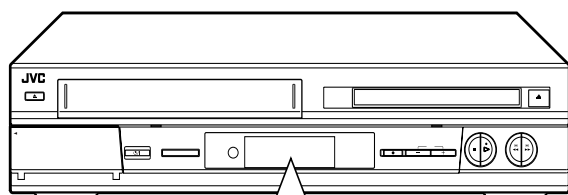

ATTENTION

- Be sure not to turn on the satellite receiver before the programme is executed; otherwise, the unit will start recording when the satellite receiver's power is turned on.
- If you have connected another appliance other than a satellite receiver to the AUDIO/VIDEO IN (L-1) connector, be sure not to engage the Automatic Satellite Programme Recording mode; otherwise, the unit will start recording when the connected appliance's power is turned on.
- Automatic Satellite Programme Recording and timer-recording cannot be done at the same time.

Before performing the following steps:

- Make sure the satellite receiver is connected to the unit's AUDIO/VIDEO IN (L-1) connector. (☞ pg. 74)
- Programme the timer on the satellite receiver.
- Insert a cassette with the safety tab in place.
- Slide the TV/S-VHS/DVD switch to the right.

1 Select the S-VHS deck.

On the unit

Press **S-VHS/DVD** repeatedly so that the S-VHS indicator lights up.

On the remote control

Press **S-VHS** so that the S-VHS indicator lights up.

2 Set the tape speed.

Press **SP/LP/EP (///)**.

- Select the appropriate colour system with "PAL/MESECAM" and "NTSC". (☞ pg. 77, 78)

3 Engage the Automatic Satellite Programme Recording mode.

Press and hold **REC LINK** for about 2 seconds. The "S-VHS" indicator lights up and the unit turns off automatically.

NOTES:

- To disengage the Automatic Satellite Programme Recording mode, press **REC LINK**. The "S-VHS" indicator goes off.
- If the unit's power is off, it is not possible to engage the Automatic Satellite Programme Recording mode.
- In step 3, if the "S-VHS" indicator does not light but instead blinks quickly even though your satellite receiver's power is off, Automatic Satellite Programme Recording will not work properly with that satellite receiver*. If this is the case, perform "Express Timer Programming" (☞ pg. 34) to timer-record a satellite programme.
* Some satellite receivers output signals even if the power is off. Automatic Satellite Programme Recording is not possible with those satellite receivers.
- The "S-VHS" indicator blinks while Automatic Satellite Programme Recording is in progress.
- For timer programming of the satellite receiver, refer to the instruction manual of the satellite receiver.
- Automatic Satellite Programme Recording is not possible if your satellite receiver does not have a timer.
- Pressing the unit's **⏻** button while Automatic Satellite Programme Recording is in progress turns off the unit's power and disengages the Automatic Satellite Programme Recording mode.
- If there are more than one satellite programmes you wish to record with Automatic Satellite Programme Recording, it is not possible to set different tape speeds for each programme.
- Depending on the type of satellite receiver, the unit may not record a slight portion of the beginning of the programme or may record slightly longer than the actual length of the programme.
- If you engage the Automatic Satellite Programme Recording mode when the satellite receiver's power is on, the unit will not start Automatic Satellite Programme Recording even though the "S-VHS" indicator blinks. When the satellite receiver shuts off once and is turned back on again, the unit starts recording.
- You can also record a programme from your cable system in the same way if the system has a timer.
- The B.E.S.T. system (☞ pg. 30) does not work while Automatic Satellite Programme Recording is in progress.

Basic Playback



- Turn on the TV and select the video channel (or AV mode).
- Slide the **TV/S-VHS/DVD** switch to the right.

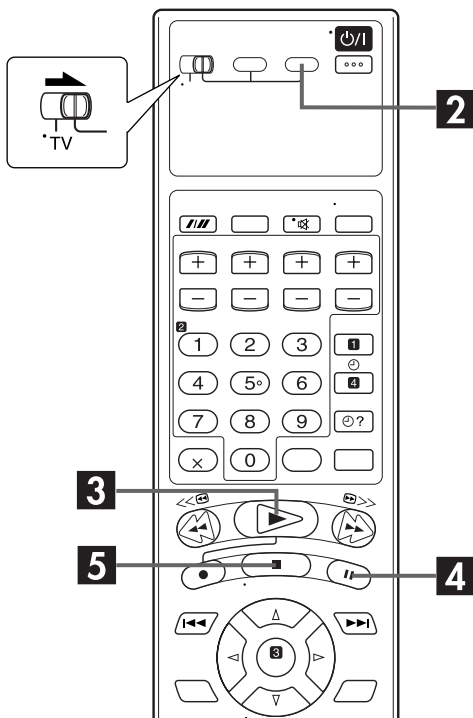
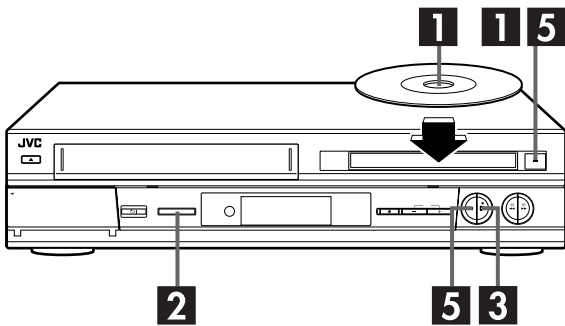

ATTENTION

- You can not use the DVD deck when the S-VHS deck is in the Automatic Satellite Programme standby and recording mode.
- You can use the DVD deck when the S-VHS deck is in the timer standby mode.

To play back a MP3/JPEG disc, see pages 62 – 67.

1 Load the disc.

- 1 Press **▲** on the DVD deck to open the disc tray.
 - The unit's power comes on automatically.
- 2 Place the disc in the disc tray.
 - For details, refer to "Placing a Disc" (☞ pg. 7).
- 3 Press **▲** on the DVD deck to close the disc tray.
 - Pressing **▶** also close the disc tray.
 - Playback begins automatically if the auto-playback DVD disc is loaded.

2 Select the DVD deck.

On the unit

Press **S-VHS/DVD** repeatedly so that the DVD indicator lights up.

On the remote control

Press **DVD** so that the DVD indicator lights up.

3 Start playback.

Press **▶**.

- It may take a few seconds to start playback.
- If you load a DVD disc whose region code does not match the DVD deck, "REGION CODE ERROR!" appears on the TV screen. For details, refer to "Region Number" (☞ pg. 5).
- If "The DISC can't play now!" appears on the TV screen, refer to "Parental Lock" (☞ pg. 58).
- With Video CD discs with PBC control or some DVD discs, the menu display may appear on the TV screen after starting playback. In this case, select an item which you want to play back from the menu. Otherwise, the playback cannot go forward. Refer to "Locating a desired scene using the menu of the Video CD with PBC" (☞ pg. 41) or "Locating a desired scene using the DVD menu" (☞ pg. 42).

4 Pause playback.

Press **⏸**.

- To resume normal playback, press **▶**.

5 Stop playback.

Press **■**. Press **▲** on the DVD deck to open the disc tray, then remove the disc.

- Pressing **▶** resume playback from the position where you stop playback. For details, see "Resume Function" on page 43.

NOTE:

When you press **▲** while the unit is turned off, the unit's power comes on and the disc tray opens automatically.

Playback Features

- Turn on the TV and select the video channel (or AV mode).
- Slide the TV/S-VHS/DVD switch to the right.

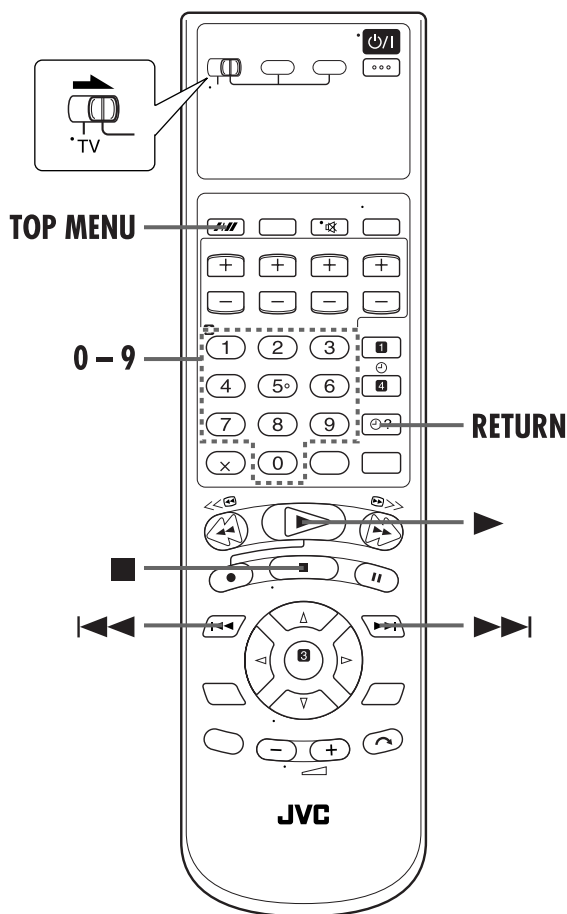

Playback Control (PBC) Function

— Locating a desired scene using the menu of the Video CD with PBC



Some Video CD discs support the PBC function. PBC is an abbreviation of "PlayBack Control." A Video CD disc recorded with PBC has its own menus, such as a list of the songs of the disc. You can locate a specific scene by using the menu.

1 Access the PBC menu.

In stop mode

Press **▶**.

During playback

Press **TOP MENU**.

- "Pbc" appears on the front display panel.

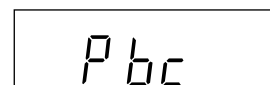
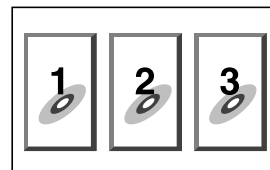

2 Start playback.

Press the appropriate **number keys**.

- The unit starts playback of the selected item.
- When "NEXT" or "PREVIOUS" appears on the TV screen:
 - Pressing **▶▶** advances to the next page.
 - Pressing **◀◀** returns to the previous page.
- You can return to the menu by pressing **RETURN**.
- The method of the operation is different depending on the disc.

NOTES:

- If you want to playback a PBC-compatible Video CD disc without activating the PBC function, start playback by using the **number keys** instead of the **▶** button.
- To activate the PBC function when a PBC-compatible Video CD disc is being played back without the PBC function, press **TOP MENU**, or press **■** then press **▶**.

Locating a desired scene using the DVD menu



DVD VIDEO discs may have two types of the menus; top menu and disc menu.

Top menu

DVD discs generally have their own menus which show the disc contents. These menus contain various items such as titles of a movie, names of songs, or artist information. You can locate a desired scene by using the top menu displayed on the TV screen. Press **TOP MENU** to access the top menu.

Disc menu

DVD discs have the disc menu to select subtitle and audio language etc. for each title.

Press **MENU** to access the disc menu.

1 Access the DVD menu.

Press **TOP MENU** or **MENU**.

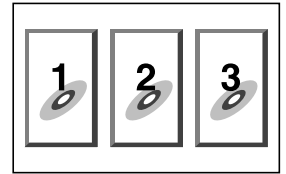

Example:

2 Start playback.

Press $\Delta \nabla \triangleleft \triangleright$ to select a desired item, then press **OK**.

- It may be possible to select the desired item using the **number keys** depending on the disc.

NOTE:

When "⊗" appears on the TV screen in step 1, the disc does not have a top menu or disc menu.

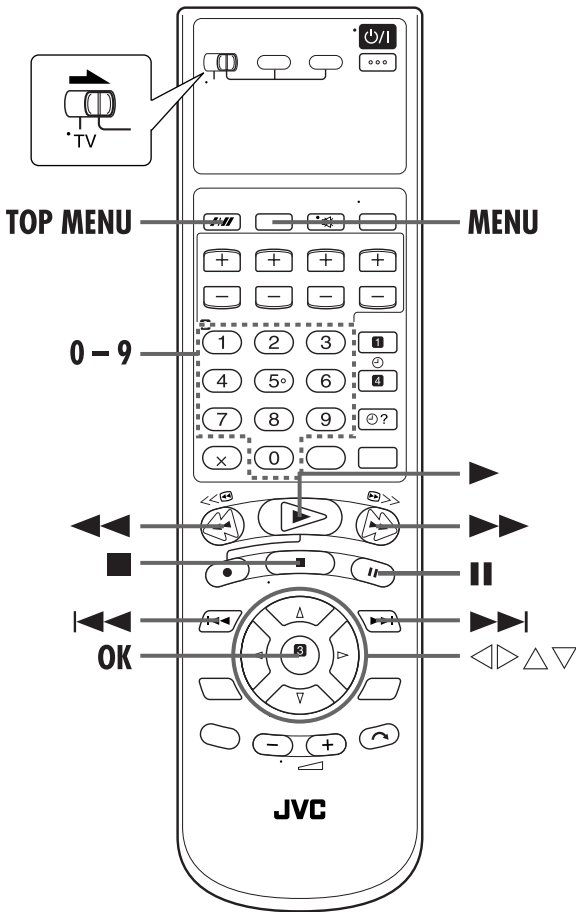

Locating the start point of the item or skip the item



Press **⏮** or **⏭** during playback.

Example:

To locate the beginning of item B from the current position, press **⏮** twice.

To locate the beginning of item D from the current position, press **⏭** once.

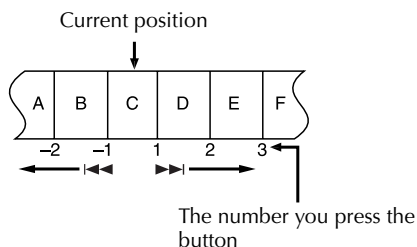

- When the specified item is located, playback begins automatically.

High-Speed Search



During playback, press **⏭** for forward high-speed search, or **⏮** for reverse high-speed search.

- To resume normal playback, press **▶**.

OR

During playback, press and hold **⏭** for forward high-speed search, or press and hold **⏮** for reverse high-speed search.

- To resume normal playback, release **⏮** or **⏭**.

Still Picture/Frame-By-Frame Playback



1 Pause during playback.

Press **⏸**.

2 Activate frame-by-frame playback.

Press **⏸**.

- When you press and hold **⏸** for more than 2 seconds, the unit enters in strobe playback pause mode. (☞ pg. 45). To cancel strobe playback mode, press and hold **⏸** for more than 2 seconds again.
- To resume normal playback, press **▶**.

Slow Motion



During still picture, press **⏮** or **⏭**.

- The speed changes for each direction by pressing **⏮** or **⏭** repeatedly.
- To resume normal playback, press **▶**.

Resume Function



It is possible to memorize the position where you stop playback and resume playback from that position.

- Be sure to set "RESUME" to "ON". (☞ pg. 82)

1 Memorize the resume point.

Press **■**.

- The unit enters Resume Stop mode and memorise the position where you stop playback as the resume point.
- "rESUM" appears on the front display panel.

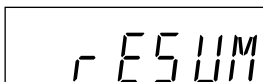

- To clear the resume point:
 - Press **⏻** to turn off the unit.
 - Eject the disc.
 - Press **■** in stop mode.
 - Set "RESUME" to "OFF". (☞ pg. 82)

2 Resume playback.

Press **▶**. The unit start playback from the resume point.

- "rESUM" appears on the front display panel.

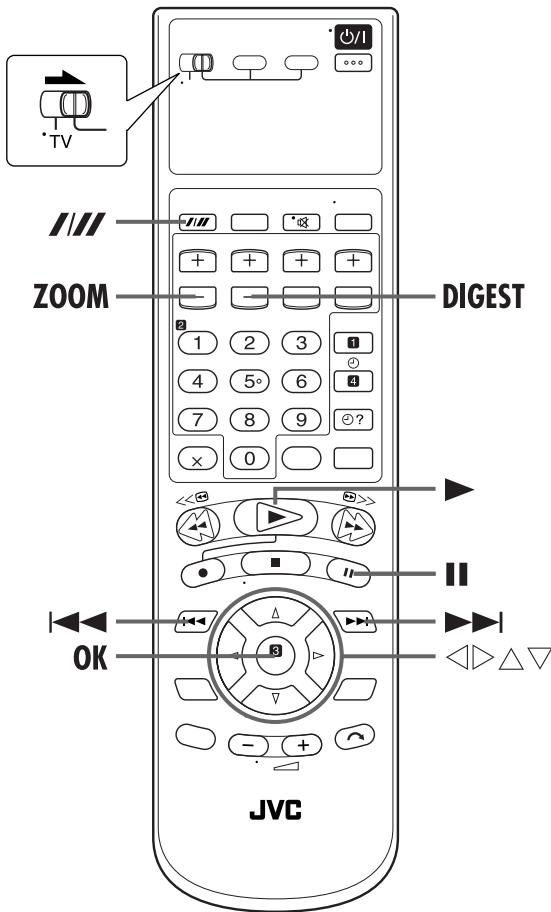

Digest



The unit can display the opening scene of each title or chapter (DVD VIDEO) or each track (Video CD). You can select a desired scene from those displayed on the TV screen.

For DVD VIDEO

In stop mode or during playback

For Video CD

In stop mode or during playback without PBC function

1 Access the digest screen.

Press **DIGEST**.

- Up to 9 opening scenes appear.

• DVD VIDEO

In stop mode, the opening scene of each title appears on the TV screen.

During playback, the opening scene of each chapter in the current title appears on the TV screen.

• Video CD

In stop mode or during playback, the opening scene of each track appears on the TV screen.

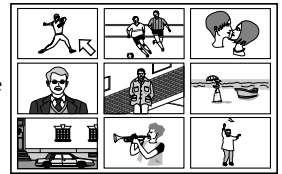

2 Start playback.

Press $\Delta \nabla \triangleleft \triangleright$ to move the arrow to the desired scene, then press **OK**.

- If there are more than 9 scenes, the digest screen will have more than one page. In this case, pressing $\triangleright \triangleright \triangleright$ advances to the next page, while pressing $\triangleleft \triangleleft \triangleleft$ returns to the previous page.



Selected scene

- When the lower right scene is selected, pressing \triangleright advances to the next page if available. Similarly, when the upper left scene is selected, pressing \triangleleft returns to the previous page (if available).

NOTE:

With some discs, it may take some time until all the scenes appear on the screen depending on the contents.

Strobe Playback

— To display continuous still pictures



During playback, press and hold **II** for more than 2 seconds at the point you want to view as continuous photographs.

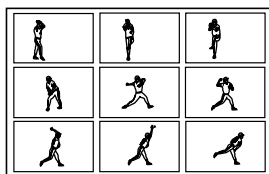

- 9 continuous still pictures appear on the TV screen.
- While the 9 still pictures are shown, pressing **II** will pause the Strobe playback. After pausing, each time you press **II**, the still picture advances frame-by-frame.
- Pressing **▶** while the 9 still pictures are shown will advance pictures in normal playback speed.
- To return to normal playback, press and hold **II** for more than 2 seconds.

NOTES:

- During the operation above, audio is not played back.
- When playing back NTSC discs, the 9 still pictures may appear vertically distorted, or a stripe may appear at the bottom of the screen. This is not a malfunction.

Zooming



Press **ZOOM** during playback or while paused.

- Each time you press **ZOOM**, the scene magnification is doubled up to the maximum 1024X.
- While zoomed, the picture may look coarse or distorted.

Current magnification

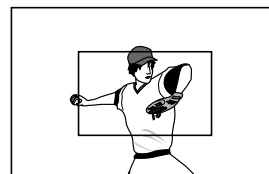

Zoomed-in area

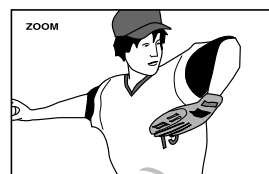

Press **△▽◀▶** to move the zoomed-in scene.

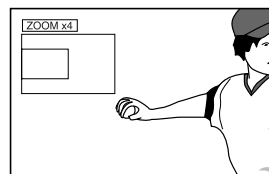

- To resume normal playback, press **OK**.

- Each time you press $\triangleleft \triangleright$, the setting changes as follows: ACTION→DRAMA→THEATER→NONE→(Back to the beginning)

ACTION:	Suitable for action movies and sports programs in which sounds dynamically move.
DRAMA:	Provides the natural and warm sound. You can enjoy movies in a relaxed mood.
THEATER:	You can enjoy sound effects like in a major theater in Hollywood.
NONE:	No effect

- The selection menu disappears automatically if you do not change the selection for 10 seconds.

3 Select the effect level.

Press $\triangle \nabla$ to select the desired effect level. (level 1 to 5)

NOTES:

- The 3D Phonic function works correctly only when playing back a DVD VIDEO disc recorded in the Dolby Digital format. With other sources, you cannot get any effect if you activate 3D Phonic function.
- When playing back a DVD VIDEO disc recorded with the Dolby Digital that does not contain the rear signal, you cannot get a correct 3D Phonic sound even if you activate 3D Phonic function.
- The 3D Phonic function does not affect the Dolby Digital bitstream signal from the DIGITAL AUDIO OUT connector.
- When you use the 3D Phonic function, it is not possible to set "ANALOG DOWN MIX" or "D. RANGE COMPRESSION". (☞ pg. 81, 82)
- To turn off the 3D Phonic display manually, press **3D-PHONIC**.
- With a Video CD disc, if the Audio setting is set to L or R, you cannot activate the 3D Phonic function and the 3D Phonic mode is fixed to off.
- Conversely, when the 3D Phonic function is activated, changing the audio setting to L or R from STEREO cancels the 3D Phonic function.

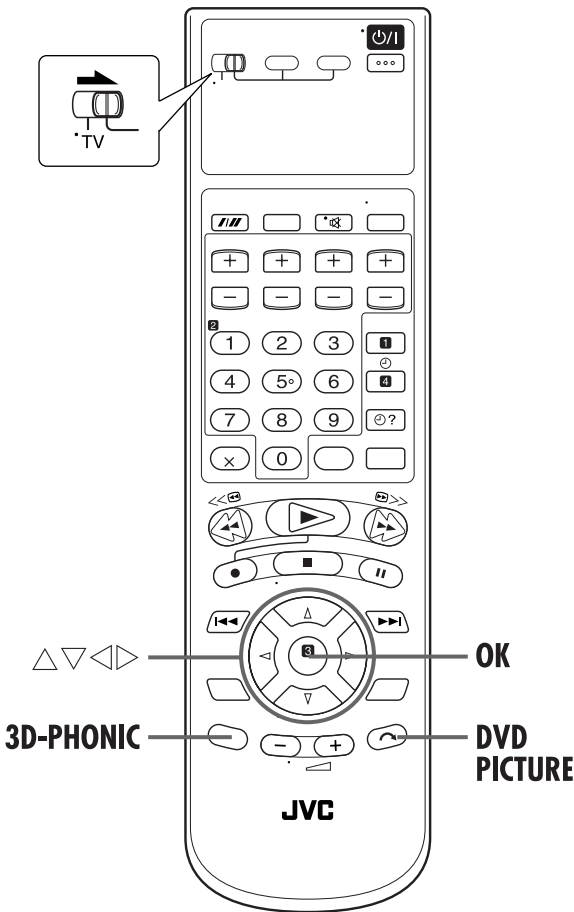

3D Phonic



3D Phonic function allows you to get a simulated surround effect from your stereo system. You can enjoy the vertical surround sound with your 2-channel stereo system.

1 Access the selection menu.

Press **3D-PHONIC** during playback.

- The current setting appears on the right bottom corner of the TV screen.

2 Select the mode.

Press $\triangleleft \triangleright$ repeatedly, then press **OK**.

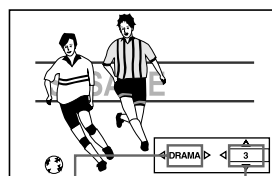

Selected mode

Effect level

VFP function

— Adjusting the picture quality



The VFP (Video Fine Processor) function enables you to adjust the picture character according to the type of programming, picture tone or personal preference.

NOTE:

Before you start operation;
The VFP setting screen disappears if no operations are done for more than about 10 seconds. If the setting screen disappears before you finish, start from step 1 again.

1 Access the VFP setting menu.

Press **DVD PICTURE** during playback.

- The current setting appears on the TV screen.

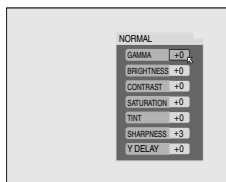

2 Select the VFP mode.

Press $\triangleleft \triangleright$ repeatedly.

- Each time you press $\triangleleft \triangleright$, the VFP mode changes as follows:
NORMAL → CINEMA → USER 1 → USER 2 → (Back to the beginning)

NORMAL:	Select this normally.
CINEMA:	Suitable for movie.
USER 1/ USER 2:	You can adjust parameters that affect picture appearance and store settings. Go to step 3.

NOTE:

You cannot adjust the parameters of "NORMAL" and "CINEMA". Press VFP to return to normal screen.

To adjust picture appearance manually

3 Access USER menu.

Press $\triangleleft \triangleright$ repeatedly to select "USER 1" or "USER 2".

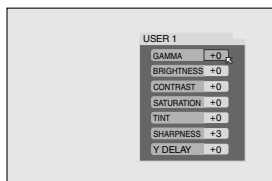

4 Select the parameter.

Press $\triangle \nabla$ repeatedly to select a parameter you want to adjust, then press **OK**.

- Adjust gradually and confirm picture appearance results are as preferred.

GAMMA (-4 to +4):	Controls brightness of neutral tints while maintaining brightness of dark and bright portions.
BRIGHTNESS (-16 to +16):	Controls screen brightness.
CONTRAST (-16 to +16):	Controls screen contrast.
SATURATION (-16 to +16):	Controls screen colour depth.
TINT (-16 to +16):	Controls screen tint.
SHARPNESS (+0 to +3):	Controls screen sharpness.
Y DELAY (-2 to +2):	Controls screen colour gap.

- VFP menu disappears and the following pop-up window appears on the TV screen.

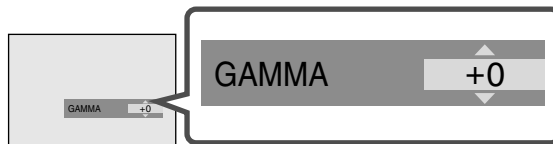

5 Adjust the parameter.

Press $\triangle \nabla$ repeatedly to change the setting, then press **OK**.

- The current VFP settings appear again.

6 Adjust the other parameters.

Repeat steps 4 and 5 to adjust other parameters.

To return to the normal screen

Press **DVD PICTURE**.

To activate your setting

Press **DVD PICTURE**, then press $\triangleleft \triangleright$ repeatedly to select "USER 1" or "USER 2" that you have changed the parameters.

Using the on-screen bar



You can check disc information while the disc is loaded and you can use some functions using the on-screen bar. The on-screen bar allows you the various playback operations.

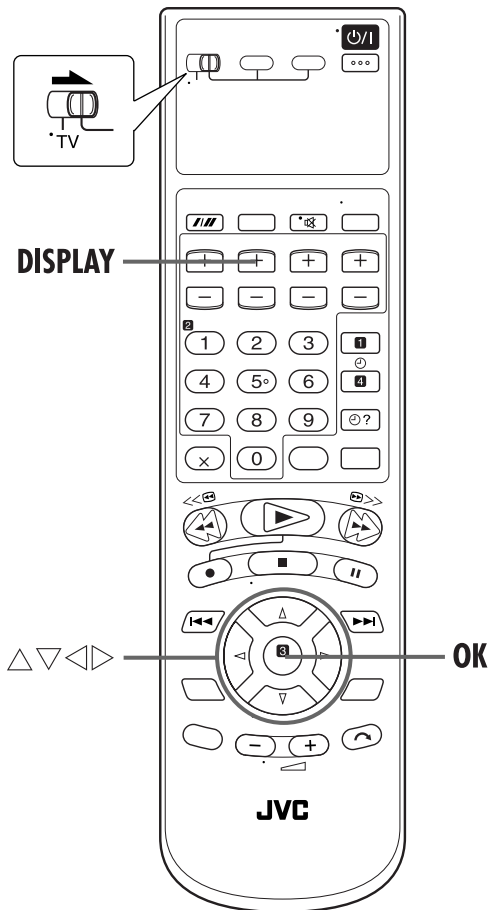

How to Access the on-screen bar

Press **DISPLAY** twice whenever a disc is loaded.

Example: During DVD playback



Example: During Video CD playback



Contents of the on-screen bar during playback

DVD

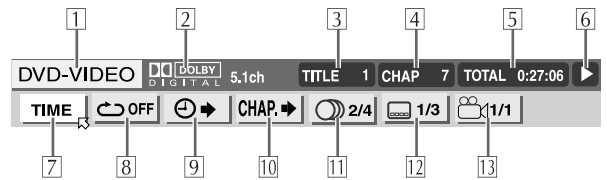

Video CD

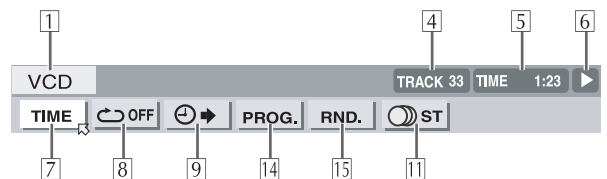

- 1 Disc type.
- 2 Audio recorded format (Dolby Digital, etc.)
- 3 Current title (for DVD) or group (for MP3) number.
- 4 Current chapter number (for DVD) or track number (for other type of discs).
- 5 Time information. (☞ pg. 49)
- 6 Playback status.
 - ▶: appears during playback.
 - ▶▶ / ◀◀: appears during fast forward/reverse.
 - ▶◀ / ◀▶: appears during playback in forward slow-motion/reverse slow-motion.
 - ⏸: appears when paused.
 - : appears when stopped.
- 7 Select this to change time information (Ⓚ). (☞ pg. 49)
- 8 Select this for Repeat Playback. (☞ pg. 50)
- 9 Select this for time search function. (☞ pg. 52)
- 10 Select this for chapter search function. (☞ pg. 51)
- 11 Select this to change audio language or channel. (☞ pg. 56, 57)
- 12 Select this to change subtitle language. (☞ pg. 54)
- 13 Select this to change view angle. (☞ pg. 55)
- 14 Select this for Program Playback. (☞ pg. 53)
- 15 Select this for Random Playback. (☞ pg. 53)

Basic operation on the on-screen bar

Example: When selecting the Repeat mode of DVD

During playback or while stopped

1 Access the on-screen bar.

Press **DISPLAY** twice. The on-screen bar appears on the TV screen.

- The currently selected item is highlighted.



2 Select menu item.

Press $\triangleleft \triangleright$ to move \boxtimes to TIME , then press **OK**. The pop-up window appears under the selected item.

- The current setting appears.



3 Select the option.

Press $\triangle \nabla$ to select the desired option, then press **OK**.

- Each time you press $\triangle \nabla$, the options change.



To clear the on-screen bar

Press **DISPLAY**.

NOTE:

See the corresponding pages for details on each function.

Change the time information



You can change the time information in the on-screen bar on the TV screen and the display window of the unit.

During playback or while stopped

1 Access the on-screen bar.

Press **DISPLAY** twice. The on-screen bar appears on the TV screen.

2 Select menu item.

Press $\triangleleft \triangleright$ to move \boxtimes to **TIME**, then press **OK**.

- Each time you press **OK**, the time information changes as follows;

Example: During DVD playback

\Rightarrow TIME 0:25:58 \Rightarrow REM 0:18:14 \Rightarrow TOTAL 1:25:58

\Rightarrow T.REM 0:45:41 \Rightarrow (Back to the beginning)

TIME:	Elapsed playing time of current chapter/track
REM:	Remaining time of current chapter/track
TOTAL:	Elapsed time of disc
T. REM:	Remaining time of disc

To clear the on-screen bar

Press **DISPLAY**.

NOTE:

While playing a Video CD or Audio CD, the hour digit indication does not appear.

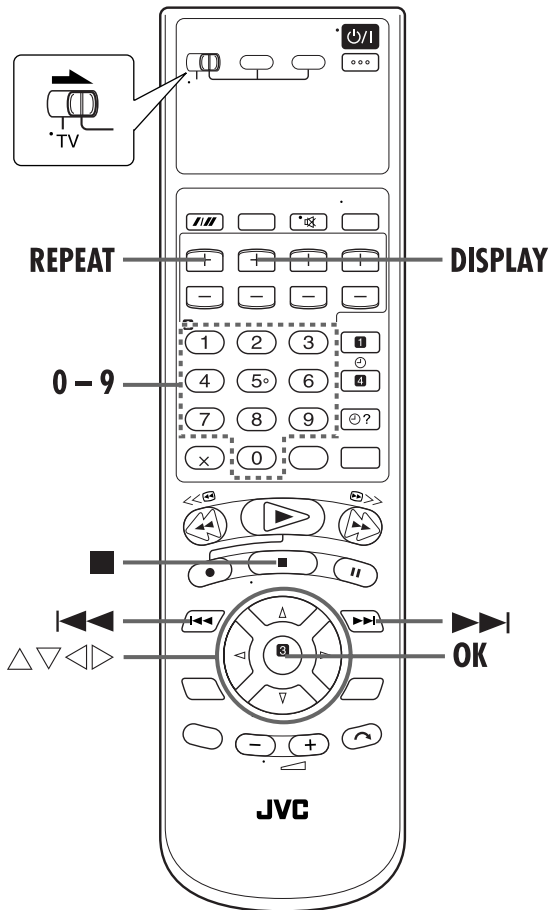

Repeat Playback



You can repeat playback as you like according to the type of disc.

When using the on-screen bar

1 Access the on-screen bar.

Press **DISPLAY** twice. The on-screen bar appears on the TV screen.

2 Select menu item.

Press \triangle / ∇ to move REPEAT to OFF , then press **OK**.

- The following pop-up window appears under the selected item.



3 Select the repeat mode.

Press \triangle / ∇ repeatedly to select the Repeat mode, then press **OK**.

- The mode changes as follows:

DVD VIDEO

CHAPTER \rightarrow TITLE \rightarrow A-B \rightarrow OFF \rightarrow (Back to the beginning)

CHAPTER:	The current chapter is played back repeatedly.
TITLE:	The current title is played back repeatedly.
A-B:	The desired part is played back repeatedly.
OFF:	Each title and chapter is played back once.

Video CD/CD

TRACK \rightarrow ALL \rightarrow OFF \rightarrow (Back to the beginning)

TRACK:	All tracks are played back repeatedly.
ALL:	The current track is played back repeatedly.
OFF:	Each track is played back once.

To clear the on-screen bar

Press **DISPLAY**.

To cancel Repeat Playback

Repeat from step **1**, select "OFF" in step **3**, then press **OK**.

When using the REPEAT button:

1 Access the repeat mode.

Press **REPEAT** during playback of the item you want to repeat.

- Repeat mode is displayed on the TV.

2 Select the repeat mode.

Press **REPEAT** repeatedly to select the desired repeat mode, then press **OK**.

- To stop Repeat Playback, press \blacksquare .
- To cancel Repeat Playback, press **REPEAT** repeatedly until "OFF" appears on the TV screen.

NOTES:

- Repeat Playback is not possible with a Video CD with PBC function.
- Repeat Playback may not work properly depending on the type of disc being used.

A-B Repeat Playback



You can repeat the desired part.

When using the on-screen bar

1 Access the on-screen bar.

Press **DISPLAY** twice. The on-screen bar appears on the TV screen.

2 Select menu item.

Press $\triangleleft \triangleright$ to move $\overline{\text{A}}$ to $\overline{\text{B}}$, then press **OK**.

- The following pop-up window appears under the selected item.



3 Select the repeat mode.

Press $\triangle \nabla$ repeatedly to select "A-B".

4 Select the start point.

Press **OK** at the beginning of the part you want to repeat (point A).

- The following display appears in the on-screen bar.

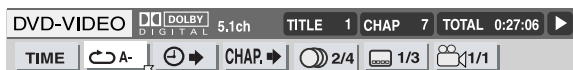

5 Select the end point

Press **OK** at the end of the part you want to repeat (point B).

- A-B Repeat Playback starts. The selected part of the disc (between point A and B) is played repeatedly.
- To clear the on-screen bar, press **DISPLAY**.
- To stop A-B Repeat Playback, press **■**.
- You can also stop Repeat Playback by pressing $\blacktriangleleft \blacktriangleright$ or $\blacktriangleleft \blacktriangleright$.

NOTES:

- A-B Repeat Playback may not work properly depending on the type of disc being used.
- The subtitles recorded around A-B point may not appear.
- The end of the item will be set as "B" point if the end of the item reached before you set the "B" point.
- When playing back a DVD, A-B Repeat Playback is possible only within the same title.
- "A-B" cannot be selected during Program and Random Playback.
- "A-B" cannot be selected while stopped.

Chapter Search



You can start playback the desired chapter using the on-screen bar.

1 Access the on-screen bar.

Press **DISPLAY** twice. The on-screen bar appears on the TV screen.

2 Select menu item.

Press $\triangleleft \triangleright$ to move $\overline{\text{A}}$ to **CHAP. \rightarrow** , then press **OK**.

- The following pop-up window appears under the selected item.



3 Select the chapter.

Press **number keys** (0-10) to enter the desired chapter number, then press **OK**.

- The unit starts playback from the selected chapter.

Examples:

To select track 5, press the **number key "5"**.

To select track 15, press the **number key "1"** and **"5"**.

To select track 25, press **number key "2"** twice, then **"5"**.

- It is not possible to use the **number key "+10"**.

If you have specified a wrong selection

Enter the appropriate **number keys** again.

- To clear the on-screen bar, press **DISPLAY**.

NOTES:

- When ⊗ is displayed on the TV screen in step **3**, the chapter you have selected is not contained in the disc, or chapter search does not work on the disc.
- Chapter Search starts automatically when you select the desired chapter in step **3** depending on the disc.

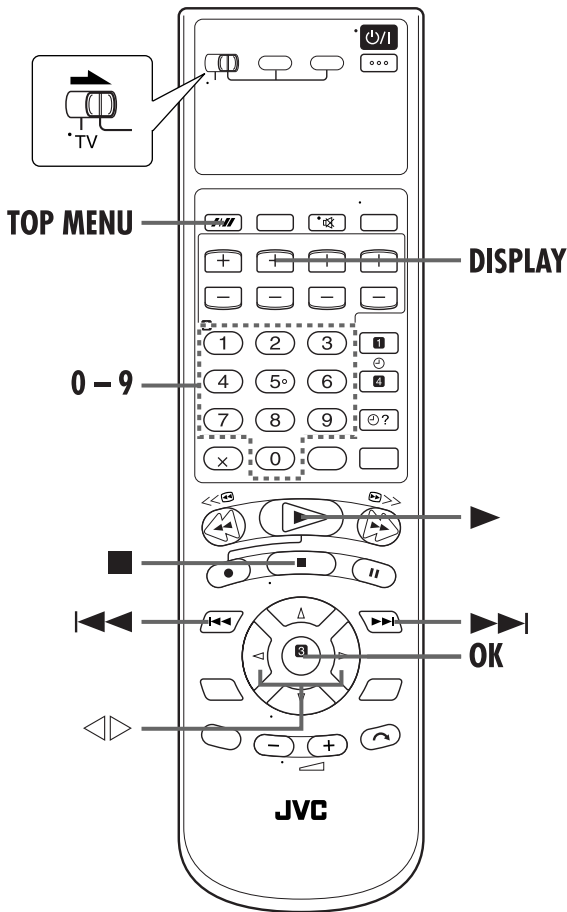

Time Search



You can play back a disc from the desired point by specifying the elapsed time from the beginning of the current title (for DVD VIDEO) or the disc (for Audio CD/Video CD) using the Time Search.

1 Access the on-screen bar.

Press **DISPLAY** twice. The on-screen bar appears on the TV screen.

2 Select menu item.

Press $\triangleleft \triangleright$ to move \blacksquare to $\odot \rightarrow$, then press **OK**.

- The following pop-up window appears under the selected item.

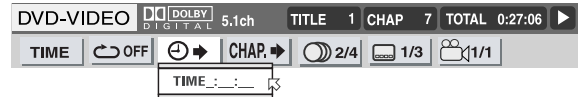

3 Select the time.

Use **number keys** (0-9) to enter the time, then press **OK**.

Example:

To play back from a point 2 (hours) : 34 (minutes) : 08 (seconds) elapsed

TIME _ : _ : _ → TIME 2 : _ : _ →
Press 2 Press 3

TIME 2 : 3 _ : _ → TIME 2 : 3 4 : _ →
Press 4 Press 0

TIME 2 : 3 4 : 0 _ → TIME 2 : 3 4 : 0 8
Press 8

If you have specified a wrong selection,

Press \triangleleft repeatedly until the wrong number is erased, then press **number keys** to enter the correct numbers.

- The unit starts playback from the specified time.

To clear the on-screen bar

Press **DISPLAY**.

NOTES:

- When “ \odot ” is displayed on the TV screen in step 2, you have selected a point that exceeds the recording time of the disc.
- Some DVD VIDEO discs do not contain time information, and it is not possible to use the Time Search function. In such a case, “ \odot ” is displayed on the TV screen as well.
- Time Search does not work while you play back the Video CD with the PBC Function. (See pg. 41, right column)

Reactivate the Playback Control (PBC) Function

You can reactivate the PBC function when you play back a PBC-compatible Video CD disc without PBC function.

- Press **TOP MENU** during playback.

Programme Playback



You can play back up to 99 tracks in the desired order.

1 Access the on-screen bar.

Press **DISPLAY** twice in stop mode.

2 Select the menu item.

Press $\triangleleft \triangleright$ to move $\overline{\text{P}}$ to "PROG.", then press **OK**.

- The programme table appears under the on-screen bar.



3 Select the tracks in the desired order.

Press the appropriate **number keys** to select the tracks.

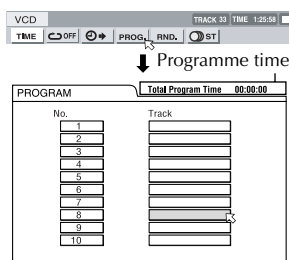

Examples:

- To select track 5, press the **number key "5"**.
- To select track 15, press the **number key "+10"** and **"5"**.
- To select track 25, press **number key "+10"** twice, then **"5"**.

If you have specified a wrong selection

Press **■**. The last selection programmed is erased.

4 Start playback.

Press **▶**. Playback starts in the selected order.

- When all of the programmed tracks have been played back, Programme Playback stops, but the programmed information remains.
- To clear the on-screen bar, press **DISPLAY**.
- To stop Programme Playback, press **■**.
- To cancel programming, press **■** in stop mode.
- During Programme Playback, pressing **▶▶** skip to the next selection of the programme. Pressing **◀◀** returns to the beginning of the current selection.

NOTE:

Programme Playback is not possible depending on the type of disc.

Random Playback



You can play back all the tracks on the disc in random order.

1 Access the on-screen bar.

Press **DISPLAY** twice in stop mode.

2 Select the menu item.

Press $\triangleleft \triangleright$ to move $\overline{\text{P}}$ to "RAND.", then press **OK**.

- Playback starts in random order.



- To clear the on-screen bar, press **DISPLAY**.
- To stop and quit Random Playback, press **■**.

NOTE:

The same track will not be played back more than once during Random Playback.

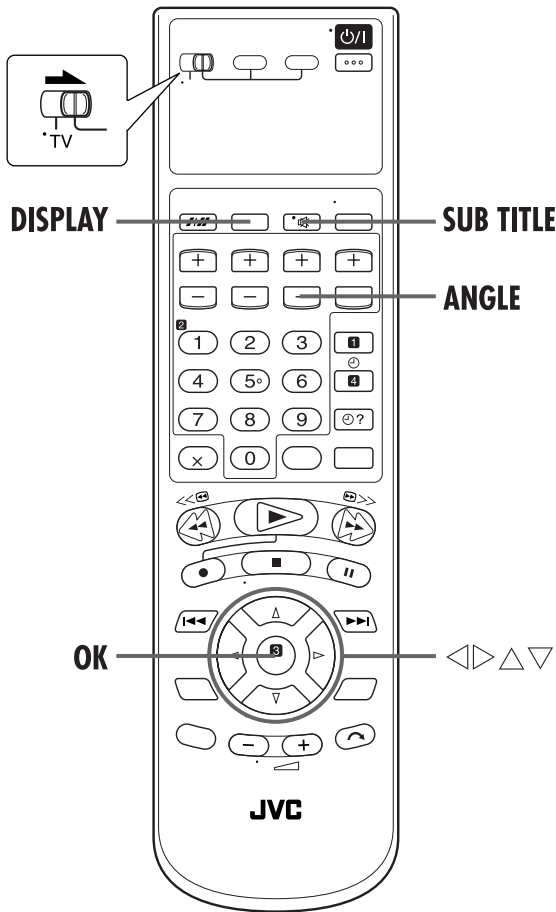

Subtitle Selection



You can select subtitle language.

- During playback

When using the SUB TITLE button:

1 Access the menu.

Press **SUB TITLE**.

- The following pop-up window appears on the TV screen.

Example (DVD): "ENGLISH" is selected out of 3 subtitle languages recorded.

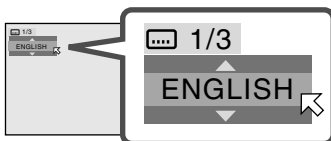

2 Select the subtitle language.

Press Δ / ∇ or **SUB TITLE** repeatedly to select the desired subtitle language.

- Each time you press the button, the subtitle language changes.
- The pop-up window disappears if no operation is done for about 5 seconds.

NOTE:

When "⊗" appears on the TV screen in step **2**, subtitle language is not recorded.

When using the on-screen bar

1 Access the on-screen bar.

Press **DISPLAY** twice. The on-screen bar appears on the TV screen.

2 Select menu item.

Press \triangleleft / \triangleright to move \boxtimes to --- , then press **OK**.

- The following pop-up window appears under the selected item.

Example (DVD): "ENGLISH" is selected out of 3 subtitle languages recorded.



3 Select the subtitle language.

Press Δ / ∇ repeatedly to select the desired subtitle language, then press **OK**.

- Each time you press the button, the subtitle language changes.

To clear the on-screen bar

Press **DISPLAY**.

NOTES:

- **For DVD VIDEO**
Some subtitle languages are abbreviated in the pop-up window. See "Language Code List" (☞ pg. 22).
- **For SVCD**
SVCD can contain up to four subtitles. Pressing **SUB TITLE** changes the subtitles regardless of whether the subtitles are recorded or not. (Subtitles will not change if no subtitle is recorded.)
- When "⊗" appears on the TV screen in step **3**, subtitle language is not recorded.

Angle Selection



You can enjoy a variety of scene angles if the DVD VIDEO disc contains "multi-angle" parts, where multiple cameras were used to shoot the same scene from different angles.

If the disc contains "multi-angle" parts, "CAM" appears on the TV screen at the beginning of the "multi-angle" part when "ON SCREEN GUIDE" is set to "ON".

- During playback

When using the ANGLE button:

1 Access the menu.

Press **ANGLE**.

- The following pop-up window appears on the TV screen.

Example: The first view angle is selected out of 3 view angles recorded.

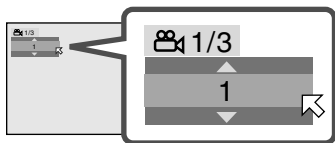

2 Select the view angle.

Press **ANGLE** repeatedly to select the desired view angle.

- Each time you press the button, the angle of the scene changes.

Example:

1/3 → 2/3 → 3/3 → (Back to the beginning)

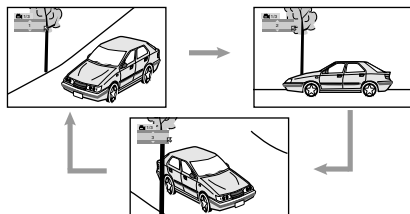

The pop-up window disappears if no operation is done for about 5 seconds.

When using the on-screen bar

1 Access the on-screen bar.

Press **DISPLAY** twice. The on-screen bar appears on the TV screen.

2 Select menu item.

Press ◀▶ to move CAM to , then press **OK**.

- The following pop-up window appears under the selected item.

Example: The first view angle is selected out of 3 view angles recorded.



3 Select the view angle.

Press ▲▼ repeatedly to select the desired view angle, then press **OK**.

- Each time you press the button, the angle of the scene changes.

To clear the on-screen bar

Press **DISPLAY**.

NOTES:

- When "CAM" appears on the TV screen in step 1, the current scene is not recorded from multiple angles.
- During the operation above, audio is not played back.

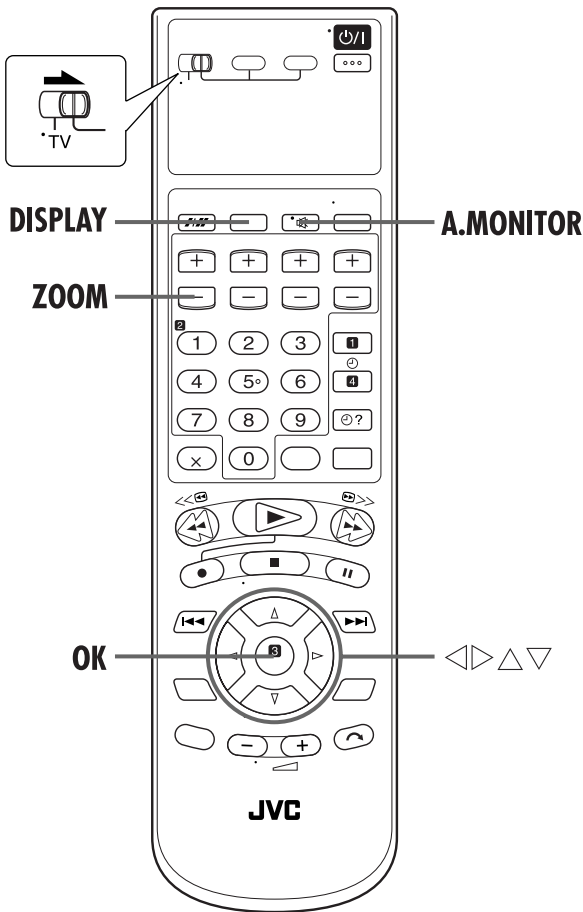

Audio Language Selection



Some DVD discs contain the multiple audio.
You can select the audio language of movies (DVD VIDEO).
• During playback

When using the A.MONITOR button:

1 Access the menu.

Press **A.MONITOR**.

- The following pop-up window appears on the TV screen.

Example: "ENGLISH" is selected out of 3 audio languages recorded.

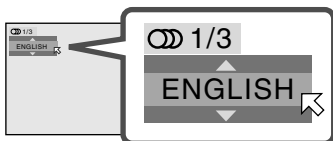

2 Select the audio language.

Press **A.MONITOR** or Δ / ∇ repeatedly to select the desired audio language.

- The pop-up window disappears if no operation is done for about 5 seconds.

NOTE:

Some audio languages are abbreviated in the pop-up window. See "Language Code List" (pg. 22).

When using the on-screen bar

1 Access the on-screen bar.

Press **DISPLAY** twice. The on-screen bar appears on the TV screen.

2 Select menu item.

Press \triangleleft / \triangleright to move ⏏ to Ⓛ , then press **OK**.

- The following pop-up window appears under the selected item.

Example: "ENGLISH" is selected out of 3 audio languages recorded.

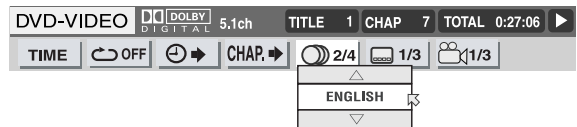

3 Select the audio language.

Press Δ / ∇ repeatedly to select the desired audio language, then press **OK**.

- Each time you press the button, the audio language changes.

To clear the on-screen bar

Press **DISPLAY**.

NOTES:

- Some audio languages are abbreviated in the pop-up window. See "Language Code List" (pg. 22)
- If "Ⓛ" appears on the TV, the current scene does not contain plural audio languages.

Audio Channel Selection



When you play certain karaoke (DVD/Video CD/SVCD), you can enjoy karaoke by selecting the audio channel to play.

- The sound of each audio channel depends on the contents of the disc.
- During playback

When using the **AUDIO** button:

1 Access the menu.

Press **A.MONITOR**.

- The following pop-up window appears on the TV screen. Example: "ST" (stereo) is selected out of 3 audio channels recorded.

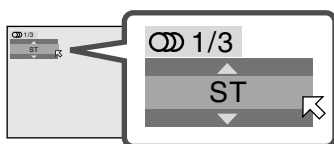

2 Select the audio channel.

Press **A.MONITOR** repeatedly to select the desired audio channel.

- Each time you press the button, the audio channel changes.

For Video CD

ST→L→R→(Back to the beginning)

ST:	To listen to normal stereo playback.
L:	To listen to L (left) audio channel only.
R:	To listen to R (right) audio channel only.

For SVCD

ST 1→ST 2→L 1→R 1→L 2→R 2→(Back to the beginning)

ST 1/ST 2:	To listen to normal stereo playback of ST 1 or ST 2 channel.
L 1/L 2:	To listen to the L (left) 1 or 2 audio channel.
R 1/R 2:	To listen to the R (right) 1 or 2 audio channel.

The pop-up window disappears if no operation is done for about 5 seconds.

When using the on-screen bar

1 Access the on-screen bar.

Press **DISPLAY** twice. The on-screen bar appears on the TV screen.

2 Select menu item.

Press ◀▶ to move ⏪ to , then press **OK**.

- The following pop-up window appears under the selected item.

Example: "ST" (stereo) is selected.

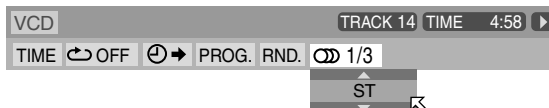

3 Select the audio channel.

Press ▲▼ repeatedly to select the desired audio channel, then press **OK**.

- Each time you press the button, the audio channel changes.

To clear the on-screen bar

Press **DISPLAY**.

Parental Lock

This function restricts playback of DVD VIDEO discs which contain violent (and other) scenes according to the level set by the user. For example, if a movie which includes violent scenes supports the parental lock feature, such scenes which you do not want to let children view can be cut or replaced with other scenes.

- Turn on the TV and select the video channel (or AV mode).
- Slide the TV/S-VHS/DVD switch to the right.

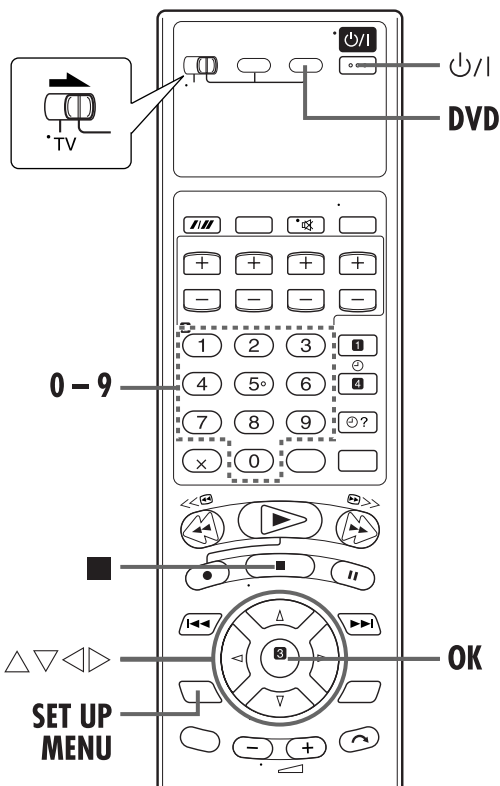

To set Parental Lock for the first time

1 Turn on the unit.

Press **p/i**.

2 Select the DVD deck.

On the unit
Press **S-VHS/DVD** repeatedly so that the DVD indicator lights up.

On the remote control
Press **DVD** so that the DVD indicator lights up.

3 Access the DVD Set Up menu.

- 1 Press **SETUP MENU**.
- 2 Press **◀▶** to select "OTHERS".

4 Access the "PARENTAL LOCK" menu.

Press **△▽** repeatedly to move **↔** to "PARENTAL LOCK", then press **OK**.

- The "PARENTAL LOCK" sub-menu appears on the TV screen.

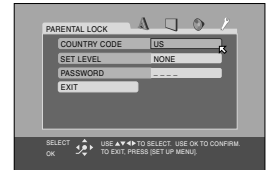

5 Access the country code menu.

Press **△▽** repeatedly to move **↔** to "COUNTRY CODE", then press **OK**.

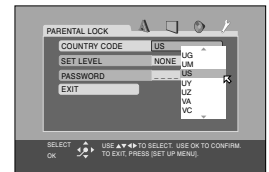

6 Select the country code.

Press **△▽** repeatedly to move **↔** to select the country code, then press **OK**.

- See "Country/Area Code List for Parental Lock" (pg. 60).
- The **↔** moves to "SET LEVEL".

7 Access the Level menu.

Press **OK**.

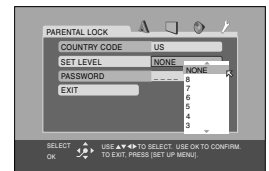

8 Select the Level.

Press **△▽** repeatedly to move **↔** to select the level of restriction, then press **OK**.

- The **↔** moves to "PASSWORD".
- The smaller the value of level is, the more restrictive the Parental Lock level is.
- Select "NONE" to cancel this function.

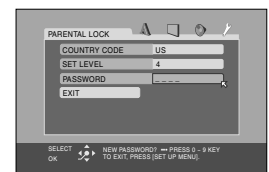

9 Enter the password.

Press the **number keys** to enter a four-digit number as your password, then press **OK**.

- The \leftarrow moves to "EXIT".

10 Return to the OTHERS menu screen.

Press **OK**.

- The "OTHERS" menu resumes.

To return to the normal screen

Press **SETUP MENU**.

NOTE:

Remember your password, or make a note of it.

To change the settings

You can change the Parental lock settings later.

1 Access the Parental Lock screen.

1 Press **SETUP MENU**.

2 Press \leftarrow to select "OTHERS".

3 Press \triangle / ∇ repeatedly to move \leftarrow to "PARENTAL LOCK", then press **OK**.

- The "PARENTAL LOCK" sub-menu appears on the TV screen.
- You can only move \leftarrow to "PASSWORD" or to "EXIT" before you enter your password.

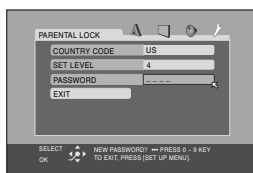

2 Enter the password.

Press the appropriate **number keys** to enter 4-digit password, then press **OK**.

- If you enter the wrong password, "WRONG! RETRY..." appears on the TV screen. Enter the correct password.

3 Change the country code.

Press \triangle / ∇ to select the country code, then press **OK**.

- See "Country/Area Code List for Parental Lock" (pg. 60).
- When you change the country code, you must select the level.

4 Change the level.

Press \triangle / ∇ to select the desired level, then press **OK**.

5 Enter your new password.

Press the appropriate **number keys** to enter 4-digit password, then press **OK**.

- The password entered in the this step becomes the new password. If you do not change the password, enter the same password as in the step 2.
- Even if you want to change only the country code and/or level, do not forget to enter the password after changing the country code and/or the level. Otherwise, the new country code and/or the level will not become effective.

6 Return to the normal screen.

Press **SETUP MENU**.

NOTES:

- When you enter the wrong password more than 3 times in step 2 above, the arrow moves to "EXIT" automatically and \leftarrow / \triangleright does not work.
- If you forget your password, enter "8888" in step 2.

To temporarily release the Parental Lock

When you set the parental level strictly, some discs may not be played back at all. When you insert such a disc and try to play back it, the following Parental Lock screen appears on the TV screen, asking you whether you want the Parental Lock to be temporarily released or not.

1 Access the password screen.

1 Place the disc in the disc tray.

- If the disc rated higher than the selected level, the following screen appears.

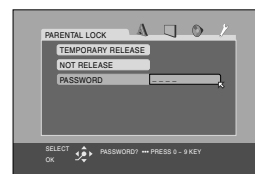

2 Press \triangle / ∇ to move \leftarrow to "TEMPORARY RELEASE", then press **OK**.

- If you select "NOT RELEASE", you cannot play back that disc.

2 Enter the password.

Press the appropriate **number keys** to enter 4-digit password, then press **OK**.

- If you enter the wrong password, "WRONG! RETRY..." appears on the TV screen. Enter the correct password.
- If you enter the correct password, the Parental lock is released and the unit starts playback.

NOTES:

- When you enter the wrong password more than 3 times in step 2 above, the arrow moves to "NOT RELEASE" automatically and \triangle / ∇ do not work. In such a case, press **OK**, then press \blacktriangle to remove the disc.
- If you forget your password, enter "8888" in step 2.

Country/Area Code List for Parental Lock

AD	Andorra
AE	United Arab Emirates
AF	Afghanistan
AG	Antigua and Barbuda
AI	Anguilla
AL	Albania
AM	Armenia
AN	Netherlands Antilles
AO	Angola
AQ	Antarctica
AR	Argentina
AS	American Samoa
AT	Austria
AU	Australia
AW	Aruba
AZ	Azerbaijan
BA	Bosnia and Herzegovina
BB	Barbados
BD	Bangladesh
BE	Belgium
BF	Burkina Faso
BG	Bulgaria
BH	Bahrain
BI	Burundi
BJ	Benin
BM	Bermuda
BN	Brunei Darussalam
BO	Bolivia
BR	Brazil
BS	Bahamas
BT	Bhutan
BV	Bouvet Island
BW	Botswana
BY	Belarus
BZ	Belize
CA	Canada
CC	Cocos (Keeling) Islands
CF	Central African Republic
CG	Congo
CH	Switzerland
CI	Côte d'Ivoire
CK	Cook Islands
CL	Chile
CM	Cameroon
CN	China
CO	Colombia
CR	Costa Rica
CU	Cuba
CV	Cape Verde
CX	Christmas Island
CY	Cyprus
CZ	Czech Republic
DE	Germany
DJ	Djibouti
DK	Denmark
DM	Dominica
DO	Dominican Republic
DZ	Algeria
EC	Ecuador
EE	Estonia
EG	Egypt
EH	Western Sahara
ER	Eritrea

ES	Spain
ET	Ethiopia
FI	Finland
FJ	Fiji
FK	Falkland Islands (Malvinas)
FM	Micronesia (Federated States of)
FO	Faroe Islands
FR	France
FX	France, Metropolitan
GA	Gabon
GB	United Kingdom
GD	Grenada
GE	Georgia
GF	French Guiana
GH	Ghana
GI	Gibraltar
GL	Greenland
GM	Gambia
GN	Guinea
GP	Guadeloupe
GQ	Equatorial Guinea
GR	Greece
GS	South Georgia and the South Sandwich Islands
GT	Guatemala
GU	Guam
GW	Guinea-Bissau
GY	Guyana
HK	Hong Kong
HM	Heard Island and McDonald Islands
HN	Honduras
HR	Croatia
HT	Haiti
HU	Hungary
ID	Indonesia
IE	Ireland
IL	Israel
IN	India
IO	British Indian Ocean Territory
IQ	Iraq
IR	Iran (Islamic Republic of)
IS	Iceland
IT	Italy
JM	Jamaica
JO	Jordan
JP	Japan
KE	Kenya
KG	Kyrgyzstan
KH	Cambodia
KI	Kiribati
KM	Comoros
KN	Saint Kitts and Nevis
KP	Korea, Democratic People's Republic of
KR	Korea, Republic of
KW	Kuwait
KY	Cayman Islands
KZ	Kazakhstan
LA	Lao People's Democratic Republic
LB	Lebanon

LC	Saint Lucia
LI	Liechtenstein
LK	Sri Lanka
LR	Liberia
LS	Lesotho
LT	Lithuania
LU	Luxembourg
LV	Latvia
LY	Libyan Arab Jamahiriya
MA	Morocco
MC	Monaco
MD	Moldova, Republic of
MG	Madagascar
MH	Marshall Islands
ML	Mali
MM	Myanmar
MN	Mongolia
MO	Macau
MP	Northern Mariana Islands
MQ	Martinique
MR	Mauritania
MS	Montserrat
MT	Malta
MU	Mauritius
MV	Maldives
MW	Malawi
MX	Mexico
MY	Malaysia
MZ	Mozambique
NA	Namibia
NC	New Caledonia
NE	Niger
NF	Norfolk Island
NG	Nigeria
NI	Nicaragua
NL	Netherlands
NO	Norway
NP	Nepal
NR	Nauru
NU	Niue
NZ	New Zealand
OM	Oman
PA	Panama
PE	Peru
PF	French Polynesia
PG	Papua New Guinea
PH	Philippines
PK	Pakistan
PL	Poland
PM	Saint Pierre and Miquelon
PN	Pitcairn
PR	Puerto Rico
PT	Portugal
PW	Palau
PY	Paraguay
QA	Qatar
RE	Réunion
RO	Romania
RU	Russian Federation
RW	Rwanda

SA	Saudi Arabia
SB	Solomon Islands
SC	Seychelles
SD	Sudan
SE	Sweden
SG	Singapore
SH	Saint Helena
SI	Slovenia
SJ	Svalbard and Jan Mayen
SK	Slovakia
SL	Sierra Leone
SM	San Marino
SN	Senegal
SO	Somalia
SR	Suriname
ST	Sao Tome and Principe
SV	El Salvador
SY	Syrian Arab Republic
SZ	Swaziland
TC	Turks and Caicos Islands
TD	Chad
TF	French Southern Territories
TG	Togo
TH	Thailand
TJ	Tajikistan
TK	Tokelau
TM	Turkmenistan
TN	Tunisia
TO	Tonga
TP	East Timor
TR	Turkey
TT	Trinidad and Tobago
TV	Tuvalu
TW	Taiwan, Province of China
TZ	Tanzania, United Republic of
UA	Ukraine
UG	Uganda
UM	United States Minor Outlying Islands
US	United States
UY	Uruguay
UZ	Uzbekistan
VA	Vatican City State (Holy See)
VC	Saint Vincent and the Grenadines
VE	Venezuela
VG	Virgin Islands (British)
VI	Virgin Islands (U.S.)
VN	Viet Nam
VU	Vanuatu
WF	Wallis and Futuna Islands
WS	Samoa
YE	Yemen
YT	Mayotte
YU	Yugoslavia
ZA	South Africa
ZM	Zambia
ZR	Zaire
ZW	Zimbabwe

About MP3 Disc

This unit can playback CD discs recorded by the MP3 format (we refer to those discs as MP3 discs in this manual).

Operations for MP3 discs are similar to those for Audio CD discs, though there are some restrictions and differences.

What is MP3?

MP3 is the abbreviation of "MPEG1 Audio Layer 3." MPEG Audio is a compression specification that compresses the audio portion only. This image compression method is used in DVD or Video CD, etc. The audio data has been compressed into about 1/10.

On an MP3 disc, each material (song) is recorded on each Track (file), which usually belongs to a Group (folder).

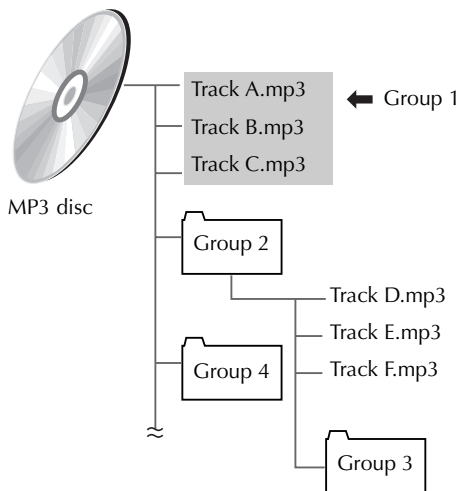

This unit can recognize up to 99 Groups and up to 150 Tracks per Group. If a disc includes more than the Tracks above limit, the unit stops detecting Tracks when the number of detected Tracks reaches the limit and ignores the subsequent Tracks. The unit also ignores any non-MP3 file in the disc.

NOTES for making a private MP3 disc using a CD-R/CD-RW disc:

- Select "ISO9660" as the disc format.
- Do not select the "multi-session" recording.
- Finalize the disc.

NOTES:

- Because of the disc characteristics or recording condition, some discs may not be played back or it takes time to start playback.
- The unit does not support "packet writing" discs.
- If there are any Tracks (files) which are stored on a disc directly and do not belong to any Group (directory), the unit recognized them as belonging to an independent Group.
- The unit does not output a digital audio signal from DIGITAL AUDIO OUT connector when playing back an MP3 disc.
- The unit plays back Groups/Tracks on an MP3 disc in the alphabetical order.
- For example, if there are three title Groups [one], [two] and [three] on a disc, the playback order is [one], [three] then [two]. Tracks in a Group are played back in the same way.
- Therefore, an MP3 disc on the market may be played back in the different order from the order printed on its sleeve.

MP3 control display

The MP3 control display appears on the TV screen and playback starts when a MP3 disc is loaded.

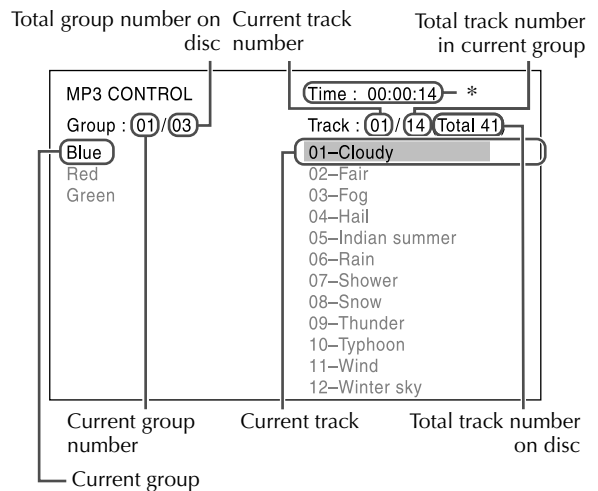

- * Elapsed playing time of current track
- Elapsed playing time is only shown during playback.

MP3 Playback

MP3

You can search and play back desired groups and tracks using the MP3 control display.

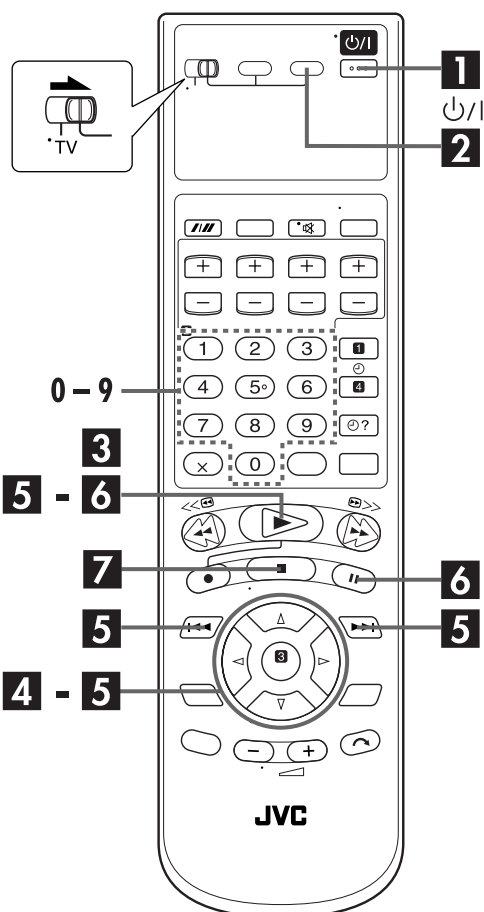
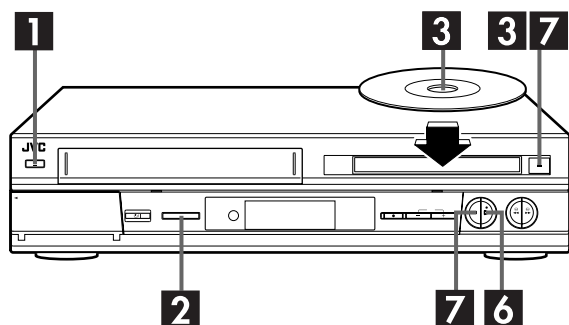

Using the MP3 control display

1 Turn on the unit.

Press /I.

2 Select the DVD deck.

On the unit

Press **S-VHS/DVD** repeatedly so that the DVD indicator lights up.

On the remote control

Press **DVD** so that the DVD indicator lights up.

- Set the type of playback files to "MP3" on the DVD Set Up menu. (☞ pg. 81)

3 Load the disc.

1 Press on the DVD deck to open the disc tray.

2 Place the MP3 disc in the disc tray.

- For details, refer to "Placing a Disc" (☞ pg. 7).

3 Press on the DVD deck to close the disc tray.

- Pressing also close the disc tray.

- The MP3 control display appears on the TV when an MP3 is loaded.

4 Select the group.

Press to select the desired group.

5 Start playback.

Press to select the desired track, then press **OK**.

- You can skip a track across a group. Press to skip to the first track of the next group when the last track of the current group is selected.

The playback starts from the selected track.

- If you select the track while stopped, press **OK** or to start playback of the select track.

6 Pause playback.

Press **II**.

- To resume normal playback, press .

7 Stop playback.

Press **■**. Press on the DVD deck to open the disc tray, then remove the disc.

NOTE:

■, **II**, and buttons function the same as with Audio CD discs, however, or does not function for MP3 playback.

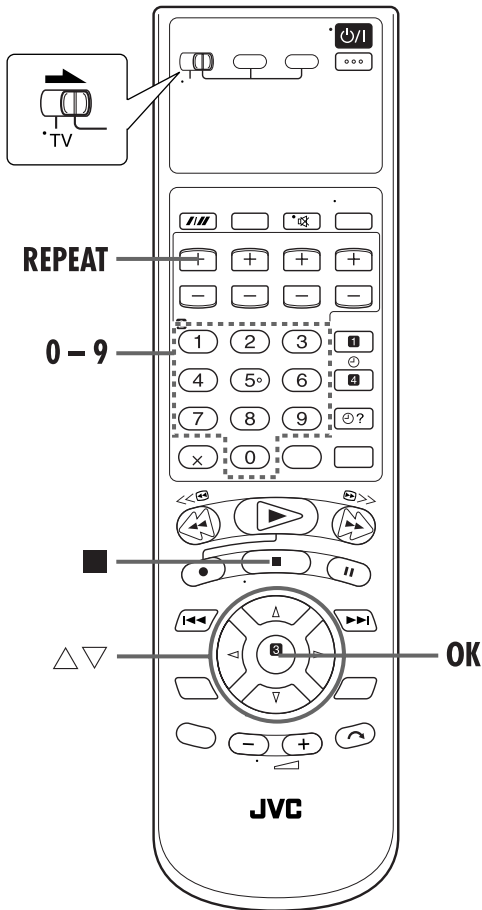

Repeat Playback

MP3

You can repeat playback of the current group, track or all groups.

- While MP3 control display is on the TV:

1 Access the repeat mode.

Press **REPEAT** during playback.

- The current repeat mode is displayed on the MP3 control display.

2 Select the mode.

Press **REPEAT** to select the desired repeat mode, then press **OK**.

- Each time you press **REPEAT**, the mode changes as follows: TRACK→GROUP→ALL→OFF (No indication)→(Back to the beginning)

TRACK:	The current track is played back repeatedly.
GROUP:	All tracks of the current group are played back repeatedly.
ALL:	All tracks are played back repeatedly.
OFF (no indication):	Each track is played back once.

- To stop Repeat Playback, press ■.
- To cancel Repeat Playback, press **REPEAT** repeatedly until the repeat mode display disappears on the TV screen.
- You can also quit Repeat Playback in the following cases:
 - Press ▲ to open the disc tray.
 - Turn off the unit.

Track/group selection

MP3

To skip groups/tracks during playback

Press ▽ repeatedly for forward-skip.

Press △ repeatedly for reverse-skip.

To start playback by specifying the track number

Press **number keys** (0-10, +10) to enter the track number.

Example:

To select 3: Press 3.

To select 14: Press +10, then 4.

To select 20: Press +10, then 10.

Or press +10 twice, then 0.

To select 24: Press +10, +10, then 4.

To select 110: Press +10 ten times, then 10.

The entered number appears in the track number indication and playback starts from the track you have specified.

About JPEG Disc

This unit can playback CD discs recorded by the JPEG format (we refer to those discs as JPEG discs in this manual). Operations for JPEG discs are similar to those for Audio CD discs, though there are some restrictions and differences.

What is JPEG?

JPEG is the abbreviation of "Joint Photographic Expert Group." JPEG is a still-picture data compression system.

On a JPEG disc, each still picture is recorded as a file, which usually belongs to a Group (folder).

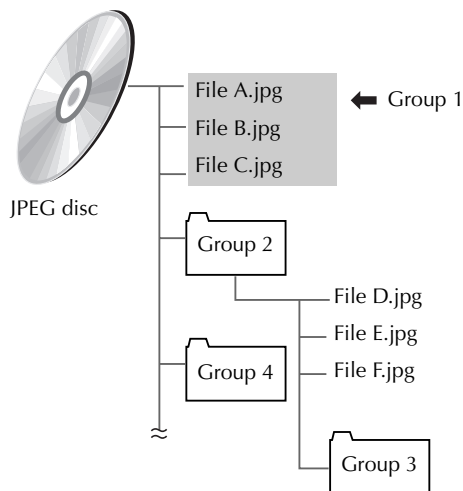

This unit can recognize up to 99 Groups and up to 150 Files per Group.

If a disc includes more than the Files above limit, the unit stops detecting Files when the number of detected Files reaches the limit and ignores the subsequent Files. The unit also ignores any non-JPEG file in the disc.

NOTES for making a private JPEG disc using a CD-R/CD-RW disc:

- Select "ISO9660" as the disc format.
- Do not select the "multi-session" recording.
- Finalize the disc.

NOTES:

- We recommend to record a file at 640 x 480 resolution. (If a file has been recorded at a resolution of more than 640 x 480, it will take a longer time to be displayed.)
- This unit can only play back baseline JPEG files*. Progressive JPEG files* or lossless JPEG files* cannot be played.
 - * Baseline JPEG format: Used for digital cameras, web, etc.
 - Progressive JPEG format: Used for web.
 - Lossless JPEG format: An old type and rarely used now.
- Some files on a JPEG disc may be played back distortedly.
- Because of the disc characteristics or recording condition, some discs may not be played back or it takes time to start playback.
- The unit does not support "packet writing" discs.
- If there are any Files which are stored on a disc directly and do not belong to any Group (directory), the unit recognized them as belonging to an independent Group.
- The unit plays back Groups/Files on an JPEG disc in the alphabetical order.
- For example, if there are three title Groups [one], [two] and [three] on a disc, the playback order is [one], [three] then [two]. Files in a Group are played back in the same way.
- Therefore, an JPEG disc on the market may be played back in the different order from the order printed on its sleeve.

JPEG control display

The JPEG control display appears on the TV screen when stopping playback of a JPEG disc.

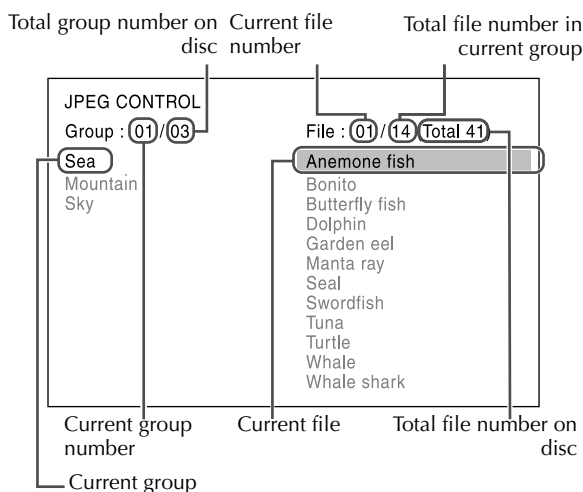

JPEG Playback

JPEG

You can search and play back desired groups and files using the JPEG control display.

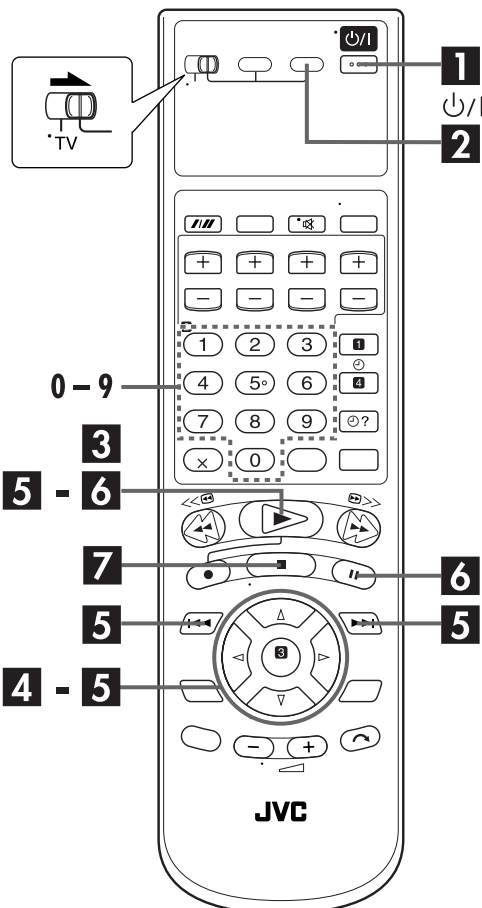
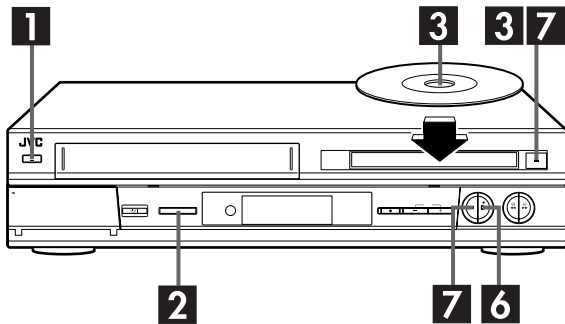

Using the JPEG control display

1 Turn on the unit.

Press P/I .

2 Select the DVD deck.

On the unit

Press **S-VHS/DVD** repeatedly so that the DVD indicator lights up.

On the remote control

Press **DVD** so that the DVD indicator lights up.

- Set the type of playback files to "JPEG" on the DVD Set Up menu. (☞ pg. 81)

3 Load the disc.

- 1 Press \blacktriangle on the DVD deck to open the disc tray.
- 2 Place the JPEG disc in the disc tray.
 - For details, refer to "Placing a Disc" (☞ pg. 7).
- 3 Press \blacktriangle on the DVD deck to close the disc tray.
 - Pressing \blacktriangleright also close the disc tray.
 - The JPEG control display appears on the TV when an JPEG is loaded.

4 Select the group.

Press $\triangleleft \triangleright$ to select the desired group.

5 Start playback.

Press $\triangle \nabla$ to select the desired file, then press **OK**.

- You can skip a file across a group. Press $\blacktriangleright \blacktriangleright$ to skip to the first file of the next group when the last file of the current group is selected.

The slide-show playback starts from the selected file.

- If you select the file while stopped, press **OK** or \blacktriangleright to start slide-show playback from the select file.

6 Pause playback.

Press **II**.

- To resume normal playback, press \blacktriangleright .

7 Stop playback.

Press **■**. Press \blacktriangle on the DVD deck to open the disc tray, then remove the disc.

NOTE:

\blacktriangleright , **■**, **II**, $\blacktriangleleft \blacktriangleleft$ and $\blacktriangleright \blacktriangleright$ buttons function the same as with Audio CD discs, however, $\blacktriangleleft \blacktriangleleft$ or $\blacktriangleright \blacktriangleright$ does not function for JPEG playback.

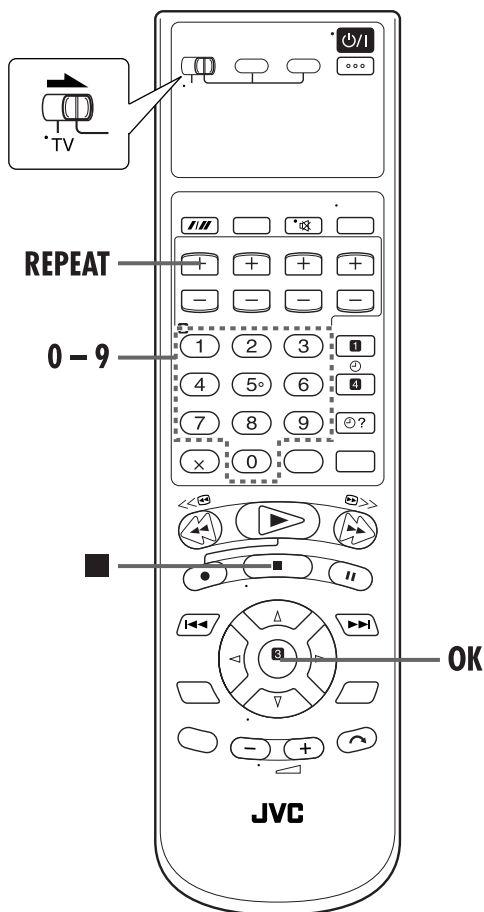

Repeat Playback

JPEG

You can repeat playback of the current group, file or all groups.

- While JPEG control display is on the TV:

1 Access the repeat mode.

Press **REPEAT** during playback.

- The current repeat mode is displayed on the JPEG control display.

2 Select the mode.

Press **REPEAT** to select the desired repeat mode, then press **OK**.

- Each time you press **REPEAT**, the mode changes as follows:
GROUP→ALL→OFF (No indication)→(Back to the beginning)

GROUP:	All files of the current group are played back repeatedly.
ALL:	All files are played back repeatedly.
OFF (No indication):	Each file is played back once.

- To stop Repeat Playback, press ■.
- To cancel Repeat Playback, press **REPEAT** repeatedly until the repeat mode display disappears on the TV screen.
- You can also quit Repeat Playback in the following cases:
 - Press ▲ to open the disc tray.
 - Turn off the unit.

To return to the JPEG control display

Press **MENU**.

File/group selection

JPEG

To start slide-show playback by specifying the file number

Press **number keys** (0-10, +10) to enter the file number.

Example:

To select 3: Press 3.

To select 14: Press +10, then 4.

To select 20: Press +10, then 10.
Or press +10 twice, then 0.

To select 24: Press +10, +10, then 4.

To select 110: Press +10 ten times, then 10.

The slide-show playback starts from the file you have specified.

Edit From A Camcorder

1 If the camcorder has no S-VIDEO output connector:

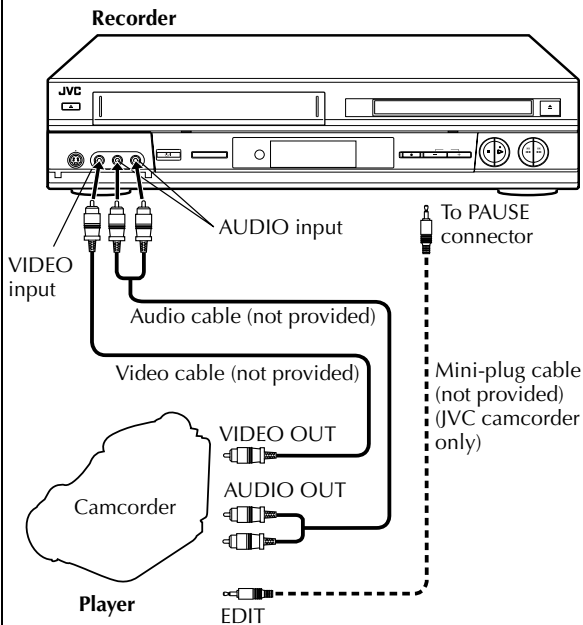

2 If the camcorder has an S-VIDEO output connector:

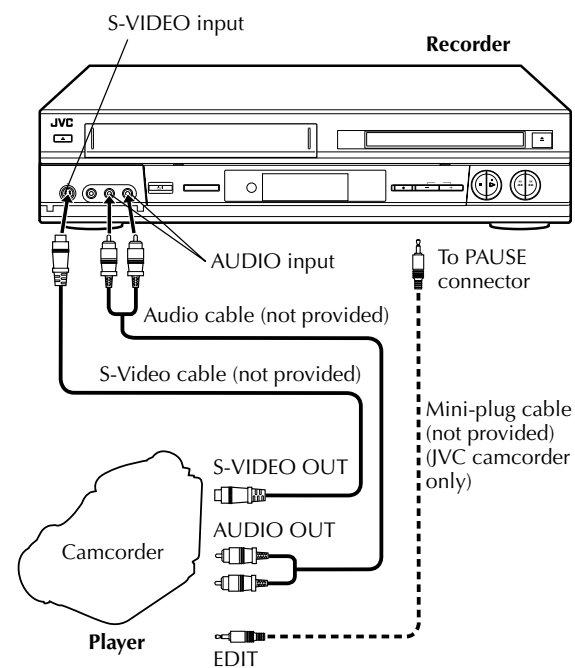

You can use a camcorder as the source player and your unit as the recording deck.

Slide the TV/S-VHS/DVD switch to the right.

1 Make connections.

- 1 If the camcorder has no S-VIDEO output connector:
 - connect the camcorder's AUDIO OUT and VIDEO OUT connectors to the unit's front panel AUDIO and VIDEO input connectors.
 - 2 If the camcorder has an S-VIDEO output connector:
 - connect the camcorder's AUDIO OUT and S-VIDEO OUT connectors to the unit's front panel AUDIO and S-VIDEO input connectors.
- When using a monaural camcorder, connect its AUDIO OUT connector to the AUDIO L input connector on your unit.
 - When a Master Edit Control-equipped JVC camcorder is used, the camcorder is capable of controlling the unit. Refer to the camcorder's instruction manual for operating procedure.

2 Select the S-VHS deck.

On the unit

Press **S-VHS/DVD** repeatedly so that the S-VHS indicator lights up.

On the remote control

Press **S-VHS** so that the S-VHS indicator lights up.

3 Set the unit's input mode.

Press **AUX** (number key "0") and/or **PR** to select "F-1" for the AUDIO and VIDEO input connectors, or "S-1" for the AUDIO and S-VIDEO input connectors, depending on the connectors being used.

4 Set the edit mode.

See "PICTURE CONTROL" on page 77.

5 Start the camcorder.

Engage the Play mode of the camcorder.

6 Start the unit.

Engage the Record mode of the unit.

NOTES:

- All necessary cables can be obtained from your dealer.
- When you select "EDIT" to dub tapes in step 4, be sure to select "AUTO" (or "NORM" when "B.E.S.T." is set to "OFF") after you finish dubbing the tapes.

IMPORTANT

- To edit, both the player and the recorder must be of the same colour system. Select the appropriate colour system. (ⓘ pg. 77, 78)
- PAL, SECAM and NTSC camcorders can be used as a player for editing.
- For more information on multi-system compatibility, refer to "Information on Multi-System Compatibility (S-VHS deck only)" (ⓘ pg. 88)

Edit To Or From Another Video Recorder

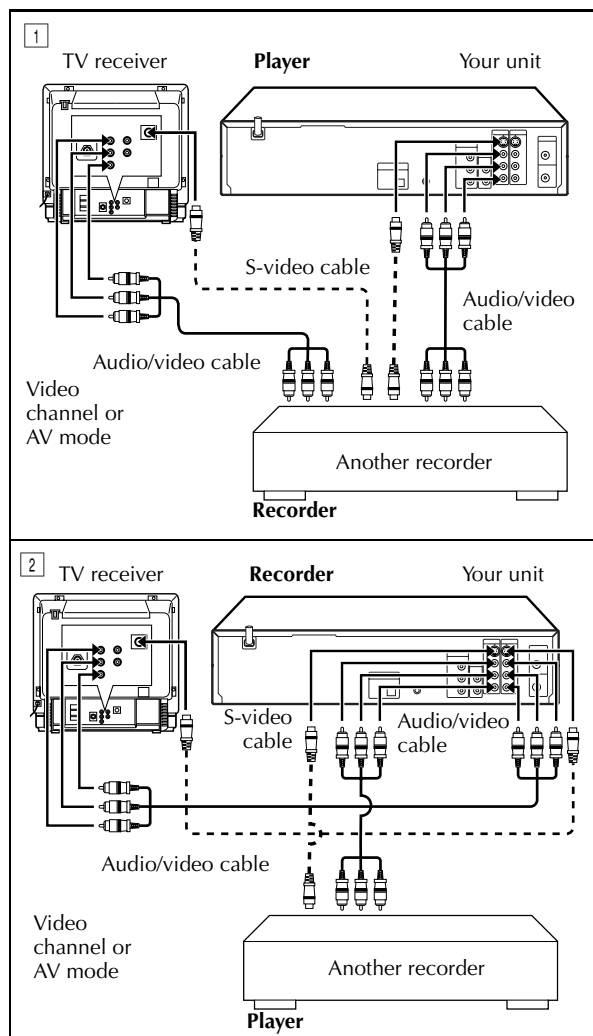

Advantages of S-VHS video recorders

You can edit from VHS to S-VHS, S-VHS to VHS, or, from S-VHS to S-VHS.

- From VHS to S-VHS: Record VHS playback signals in the S-VHS mode. Although the picture quality is inherently limited by that of the original, the edited tape has better picture quality than those made by VHS-to-VHS editing.
- From S-VHS to VHS: Because the picture quality of the source material is very high, the edited tape has better picture quality than those made by VHS-to-VHS editing.
- From S-VHS to S-VHS: All signals will be transferred with minimum degradation.

You can use your unit as the source player or as the recording deck.

Slide the **TV/S-VHS/DVD** switch to the right.

1 Make connections.

- 1 When using your unit as the source player ...
... connect its **AUDIO/VIDEO OUT** or **AUDIO/S VIDEO OUT** connectors to the audio/video or audio/S-video input connectors on another recorder.
- 2 When using your unit as the recording deck ...
... connect its **AUDIO/VIDEO IN** or **AUDIO/S VIDEO IN** connectors to the audio/video or audio/S-video output connectors on another recorder.

2 Select the S-VHS deck.

On the unit

Press **S-VHS/DVD** repeatedly so that the S-VHS indicator lights up.

On the remote control

Press **S-VHS** so that the S-VHS indicator lights up.

3 Set the input mode of recording deck.

With this video unit, press **AUX** (number key "0") and/or **PR** to select "L-1" for the **AUDIO/VIDEO IN** connectors, or "S-1" for the **AUDIO/S VIDEO IN** connectors, depending on the connector being used.

- When using another recorder as the recording deck, refer to its instruction manual.

4 Set the edit mode.

See "PICTURE CONTROL" on page 77.

5 Start the source player.

Engage the Play mode of the source player.

6 Start the recording deck.

Engage the Record mode of the recording deck.

NOTES:

- All necessary cables can be obtained from your dealer.
- When you select "EDIT" to dub tapes in step 4, be sure to select "AUTO" (or "NORM" when "B.E.S.T." is set to "OFF") after you finish dubbing the tapes.
- When you use this unit as the source player for editing, be sure to set "O.S.D." to "OFF" before starting. (☞ pg. 78)
- It is also possible to use the front **AUDIO/VIDEO** or **AUDIO/S-VIDEO** input connectors for the connection. When you use the front connectors, select "F-1" for the **AUDIO/VIDEO** input connectors, "S-2" for the **AUDIO/S-VIDEO** input connectors in step 3.

IMPORTANT

- To edit, both the player and the recorder must be of the same colour system. Select the appropriate colour system. (☞ pg. 77, 78)
- For more information on multi-system compatibility, refer to "Information on Multi-System Compatibility (S-VHS deck only)" (☞ pg. 88)

Dubbing

(from DVD to S-VHS)

- Turn on the TV and select the video channel (or AV mode).
- Slide the TV/S-VHS/DVD switch to the right.

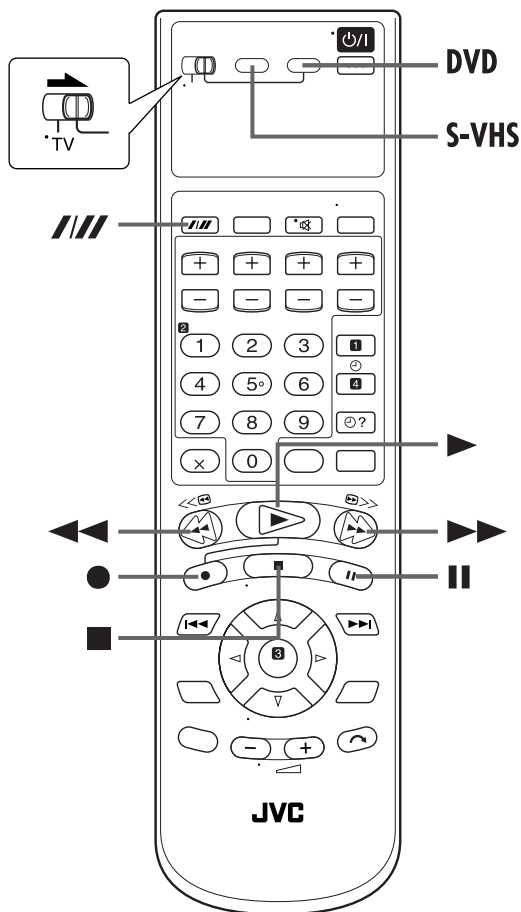

You can dub selected scenes from the DVD disc to a cassette, starting and stopping wherever you wish. However, it is not possible to dub the copy-protected disc.

1 Load a cassette and place a disc.

For the S-VHS deck

Insert a cassette with the record safety tab intact.

For the DVD deck

- 1 Press on the DVD deck to open the disc tray.
- 2 Place the disc in the disc tray.
- 3 Press on the DVD deck to close the disc tray.

2 Prepare the S-VHS deck for dubbing.

- 1 Press S-VHS.
- 2 Press to select recording speed.
- 3 Search for the point where you want to start dubbing by pressing , or then press .

3 Prepare the DVD deck for dubbing.

- 1 Press DVD.
 - 2 Search for the point where you want to start dubbing by pressing , or .
 - 3 Press to pause playback a little before the start point.
 - 4 Press and hold , then press .
- “dub” blinks on the front display panel.

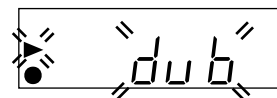

4 Start dubbing.

Press to start playback.

5 End dubbing.

Press .

NOTES:

- Set “ON SCREEN GUIDE” to “OFF” (pg. 82) if you do not want to record the on-screen display for DVD discs during dubbing.
- There may be a discrepancy of several seconds between where you intend editing to start, and where it actually starts.
- The superimposed indication during the operation or dubbing is not recorded.

Digital Audio Dubbing

- Turn on the TV and select the video channel (or AV mode).
- Slide the TV/S-VHS/DVD switch to the right.

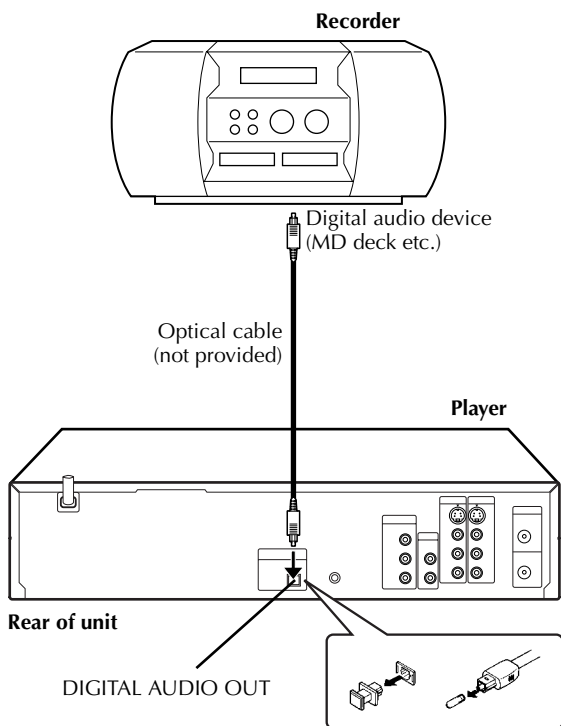

You can dub selected audio from the DVD or Audio CD disc to a MD etc. However, it is not possible to dub the copy-protected disc.

Example: Dubbing to a MD

1 Make connections.

Connect the optical cable between the unit and the digital audio device.

2 Place a disc and load a MD.

For the DVD deck

- 1 Press **▲** on the DVD deck to open the disc tray.
- 2 Place the disc in the disc tray.
- 3 Press **▲** on the DVD deck to close the disc tray.

For the digital audio device

Insert a MD.

3 Prepare the DVD deck for dubbing.

- 1 Press **DVD** and select the audio to be dubbed.
- 2 Search for the point where you want to start dubbing by pressing **▶**, **▶▶** or **◀◀** then press **■**.
- 3 Press **◀◀** a little, then press **▶** to start playback.
- 4 Press **||** to pause playback a little before the start point.

4 Prepare the audio device for dubbing.

Select the input mode.

5 Start dubbing.

- 1 Press **▶** to start playback on the DVD deck.
- 2 Start recording on the audio device.

6 End dubbing.

Stop recording on the audio device. Then press **■** to stop playback on the DVD deck.

NOTES:

- There may be a discrepancy of several seconds between where you intend editing to start, and where it actually starts.
- You can also dub a Video CD or SVCD. Set "DIGITAL AUDIO OUTPUT" to "PCM ONLY". (☞ pg. 81)

Remote Control Functions

Remote A/B/C/D Code Switching

The remote control is capable of controlling four JVC video units independently. Each of units can respond to one of four codes (A, B, C or D). The remote control is preset to send A code signals because your unit is initially set to respond to A code signals. You can easily modify your unit to respond to B, C or D code signals.

Before performing the following steps:
Slide the TV/S-VHS/DVD switch to the right.

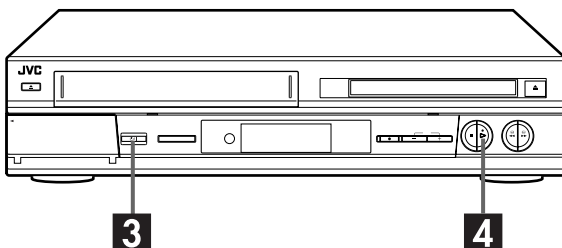
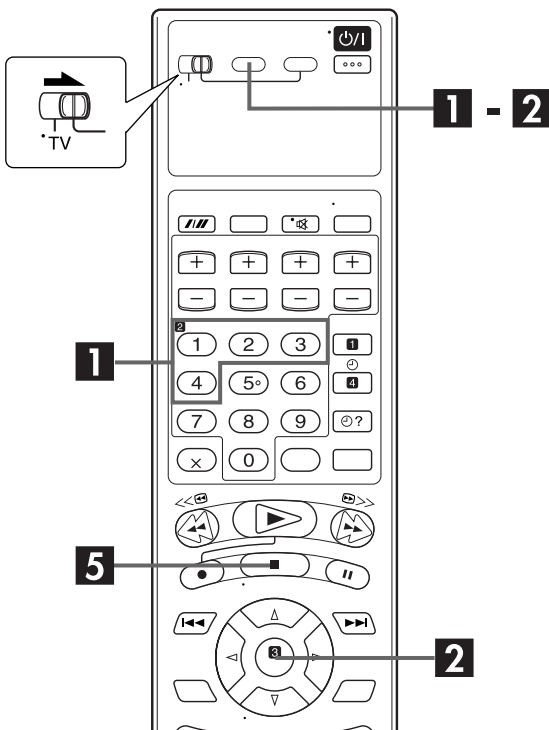

On the remote control

Keep pressing S-VHS down during steps **1** - **2**.

1 Change the remote control code.

Press the number key "1" for A, "2" for B, "3" for C or "4" for D.

2 Set the remote control code.

Press **OK** to set the code.

On the unit

3 Turn off the unit.

Press **⏻/I**.

4 Display the code.

Press **▶** on the unit for over 5 seconds while the unit is turned off. The code currently set appears on the front display panel.

- If the code displayed on the front display panel is different from the code set on the remote control, go to step **5**.

5 Change the unit's code.

Press **■** on the remote control. The code currently set on the remote control will be applied to the unit.

TV Multi-Brand Remote Control

Your remote control can operate the basic functions of your TV set. In addition to JVC TVs, other manufacturer's TVs can also be controlled.

Before performing the following steps:

- Turn off the TV using its remote control.
- Slide the TV/S-VHS/DVD switch to the left.

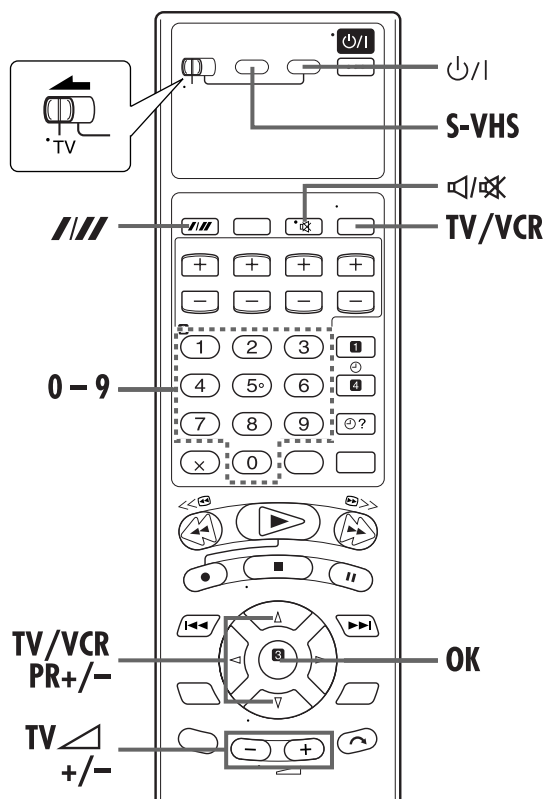

IMPORTANT

Although the provided remote control unit is compatible with JVC televisions, as well as many other models, it may not work with your TV, or in some instances, may have limited function capability.

Control Your TV Using Additional Buttons

Use the **number keys**, and the **///** button or **X** button to select the TV's channel.

- With televisions under Code 01, 02, 07, 10, 11, 14, 20, 23, 24, 25, 27, 33 or 35, the **///** button corresponds to the 1-digit/2-digit entry switching button (often labelled -/-) of your TV's remote control.
- With televisions under Code 01, 28, 29 or 34, the **X** button corresponds to the 10 + button of your TV's remote control.

NOTE:

The way these buttons are used is determined by your TV. Use these buttons as instructed for your TV's remote control.

1 Set the TV brand code.

Keep pressing **S-VHS** down during step **1**.

Enter your TV's brand code using the **number keys**, then press **OK**.

Press **⏻** on the unit's remote control to turn on the TV and try operations (see step **2**).

- Once you have set the remote control to operate the TV, you do not have to repeat this step until you replace your remote control's batteries.
- Some brands of TV have more than one code. If the TV does not function with one code, try entering another.

2 Operate the TV.

Press the corresponding button: **⏻**, **TV/VCR**, **TV/VCR PR +/-**, **TV +/-** (Volume), **⏻** (TV Muting), **number keys**.

- For some brands of TV, you must press **OK** after having pressed the **number keys**.

BRAND NAME	CODE
JVC	01, 23, 24, 25
AIWA	36
BEIJING	22
CCE	02
CHANGHONG	34
DAEWOO	37
FERGUSON	27
FINLUX	30
FUNAI	32
LG/GOLDSTAR	18
GRADIENTE	20
GRUNDIG	19
HITACHI	10
ITT	28
JINXING	38
KONKA	40
MITSUBISHI	03
MIVAR	29
NEC	20
NOBLEX	22
NOKIA	31
PANASONIC	04, 11
PEONY	34, 38, 39
PHILCO	10
RCA	05
PHILIPS	02
SAMSUNG	12, 33, 34, 35
SANYO	13, 16
SEARS	13
SHARP	06
SONY	07
TCL	41
THOMSON	26
TOSHIBA	08, 14
ZENITH	09

Connecting To A Satellite Receiver

Connect the satellite receiver to the AUDIO/VIDEO IN or S VIDEO IN connectors, then connect the AUDIO/VIDEO OUT or S VIDEO OUT connectors to the TV's connectors.

NOTES:

- You cannot use Automatic Satellite Programme Recording function if you connect the satellite receiver with S-video cable (see pg. 39).
- To record a programme via the satellite receiver, select L-1 or S-1 mode by pressing **AUX (number key "0")** and/or **PR** so that "L-1" or "S-1" appears on the front display panel.
- For details, refer to the instruction manual of the satellite receiver.

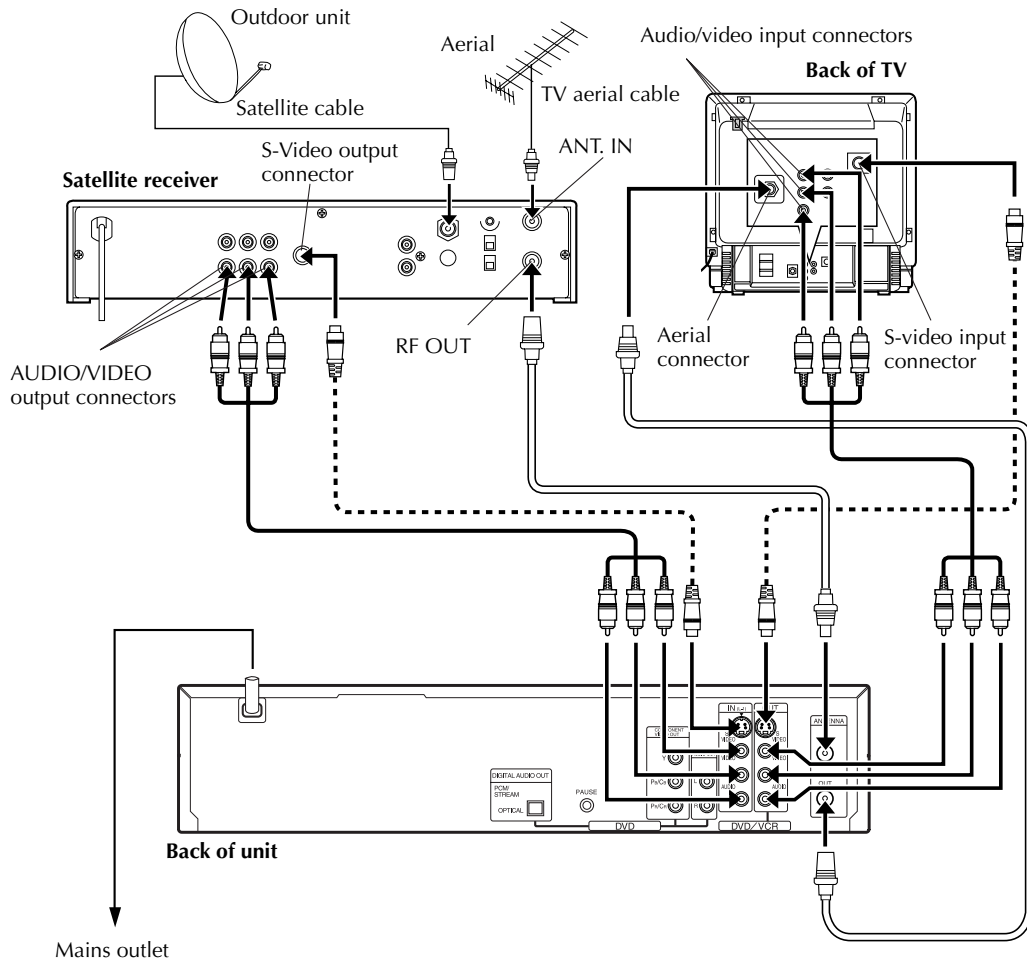

Connecting To A Dolby Digital Decoder or An Amplifier With A Built-in DTS

(DVD deck only)

These instructions enable you to connect your unit to dolby digital decoder or amplifier with a built-in DTS.

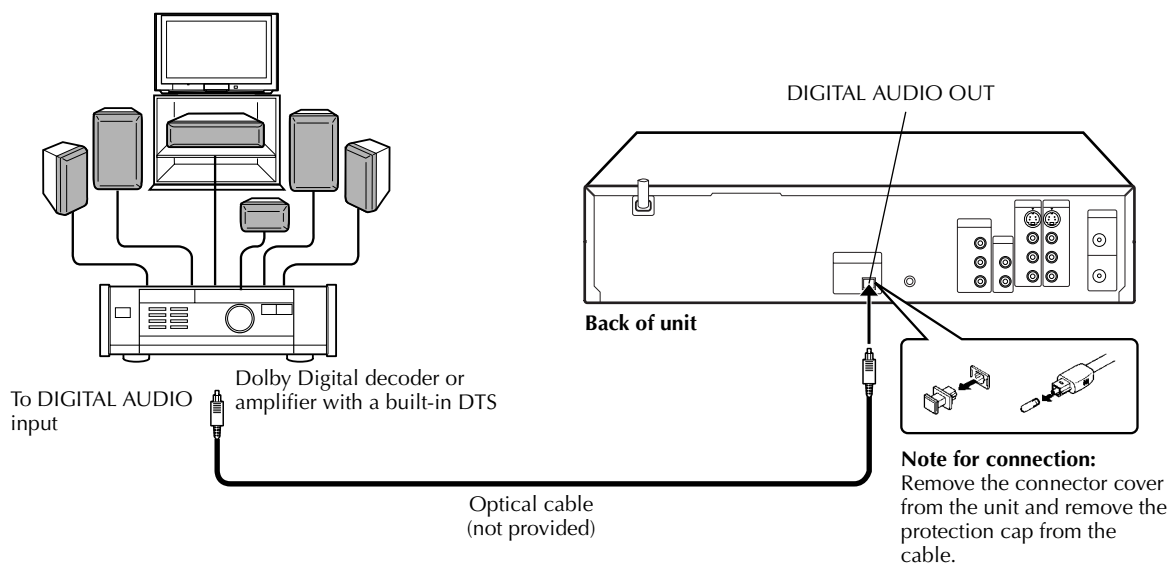

Make connections.

Connect the optical cable between the unit and the Dolby Digital decoder or amplifier with a built-in DTS.

NOTES:

- For Dolby digital sound, set "DIGITAL AUDIO OUTPUT" to "DOLBY DIGITAL/PCM". (☞ pg. 81)
- For DTS sound, set "DIGITAL AUDIO OUTPUT" to "STREAM PCM". (☞ pg. 81)

CAUTIONS:

- This unit has a dynamic range of more than 80 dB with regards to its Hi-Fi audio capability. It is recommended that you check the maximum level if you are going to listen to the Hi-Fi audio signals through a stereo amplifier. A sudden surge in the input level to the speakers may damage them.
- Some speakers and televisions are specially shielded to prevent television interference. If both are of the non-shielded type, do not place the speakers adjacent to the TV set as this can adversely affect the video playback picture.

Mode Set

(S-VHS deck)

- Turn on the TV and select the video channel (or AV mode).
- Slide the TV/S-VHS/DVD switch to the right.

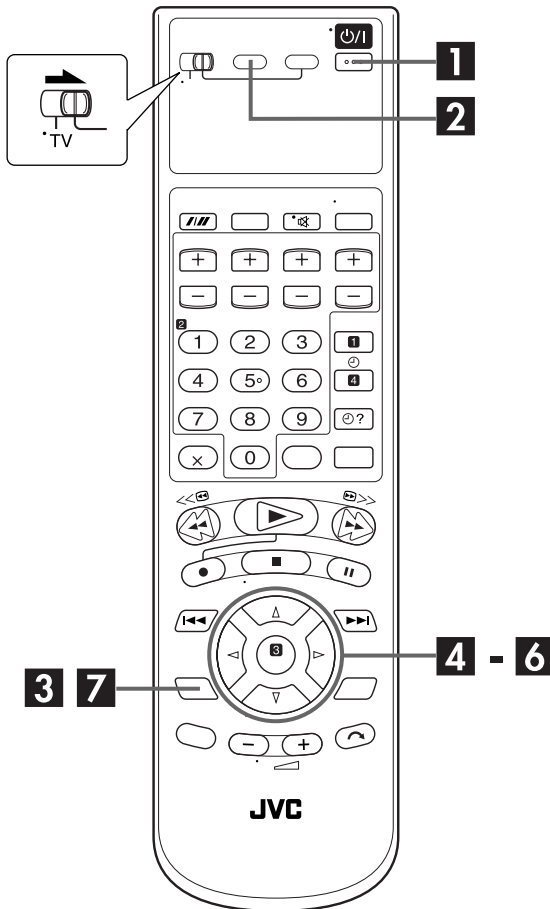

You can change various mode settings on the Function Set screen by following the procedure described below.

- For each mode setting, see pages 77 to 79.

1 Turn on the unit.

Press \odot /I.

2 Select the S-VHS deck.

On the unit

Press S-VHS/DVD repeatedly so that the S-VHS indicator lights up.

On the remote control

Press S-VHS so that the S-VHS indicator lights up.

3 Access the Main Menu screen.

Press SET UP MENU.

4 Access the Function Set screen.

Press Δ / ∇ to move the highlight bar (pointer) to "FUNCTION SET", then press OK or \triangleright .

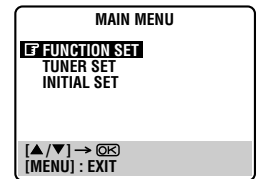

5 Select the mode.

Press Δ / ∇ to move the highlight bar (pointer) to the item you want to change.

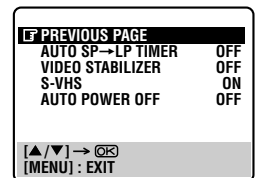
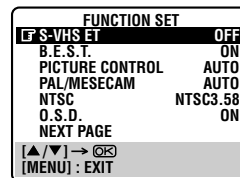

6 Select the mode setting.

Press OK or \triangleright .

7 Return to the normal screen.

Press SET UP MENU.

* The default setting is **bold** in the table below.

<p>■ S-VHS ET ON OFF</p>	<p>You can record in SP mode on VHS cassettes with S-VHS picture quality. You can play back a tape recorded using the S-VHS ET function on most of S-VHS recorders and of VHS recorders equipped with SQPB (S-VHS QUASI PLAYBACK) function. (Notice some recorders are not compatible with the S-VHS ET function.) When this function is set to "ON", the S-VHS indicator lights up on the front display panel.</p> <p>NOTES:</p> <ul style="list-style-type: none"> • You can activate the S-VHS ET function only before you start recording on a VHS cassette. • Before recording, make sure that "B.E.S.T." is set to "ON". (☞ below) • You cannot activate the S-VHS ET function: <ul style="list-style-type: none"> — while recording is in progress. — while timer-recording or Instant Timer Recording (☞ pg. 28, 32, 34) is in progress. — while B.E.S.T. (☞ pg. 30) is in progress. • The S-VHS ET function does not work: <ul style="list-style-type: none"> — with S-VHS cassettes. — with recordings in LP/EP mode. • To keep the highest quality recording and playback pictures over a long period of time, S-VHS recording on S-VHS cassettes is recommended. • Use of high grade tapes is recommended for S-VHS ET recordings. On some tapes, picture quality will not improve even if the S-VHS ET function is used. Check the recording quality before you start important recordings. • While playing back a tape recorded using the S-VHS ET function on some recorders, noise may appear. (If playback picture becomes blurred or interrupted, use a cleaning cassette.) • In the high-speed search, still, slow-motion or frame-by-frame playback modes (☞ pg. 24, 25), noise may appear. If these modes are performed frequently on a tape recorded using the S-VHS ET function, the tape may be damaged and the picture may be deteriorated.
<p>■ B.E.S.T. ON OFF</p>	<p>You can set the B.E.S.T. (Biconditional Equalised Signal Tracking) system to "ON" or "OFF". (☞ pg. 30)</p>
<p>■ PICTURE CONTROL AUTO EDIT SOFT</p>	<p>This feature helps you to adjust the playback picture quality according to your preference. Normally select "AUTO".</p> <p>AUTO: Provides the optimised picture benefits of the B.E.S.T. Picture System.</p> <p>EDIT: Minimizes picture degradation during editing (recording and playback).</p> <p>SOFT: Reduces image coarseness when viewing overlapped tapes containing a lot of noise.</p> <p>NOTES:</p> <ul style="list-style-type: none"> • When you select "EDIT" or "SOFT", the selected mode will not change until you select another mode. • When you select "EDIT" to dub tapes, be sure to select "AUTO" after you finish dubbing the tapes. • When "B.E.S.T." is "OFF", "PICTURE CONTROL" switches automatically from "AUTO" to "NORM".
<p>■ PAL/MESECAM AUTO PAL MESECAM</p>	<p>Select the appropriate colour system for recording or playback.</p> <p>AUTO: Usually set to this mode. The appropriate colour system (PAL or MESECAM) will be selected depending on the playback or recording signals.</p> <p>If the "AUTO" mode does not work properly, select either of the following manual modes.</p> <p>PAL: To record PAL signals, or playback a PAL tape</p> <p>MESECAM: To record SECAM signals, or playback a SECAM or MESECAM tape.</p> <p>NOTES:</p> <ul style="list-style-type: none"> • SECAM signals will always be recorded as MESECAM. Select "AUTO" or "MESECAM" when recording SECAM signals. • When playing back a SECAM tape, select "AUTO" or "MESECAM". The playback picture will always be monochrome.

* The default setting is **bold** in the table below.

<p>■ NTSC NTSC 3.58 NTSC 4.43 NTSC→PAL</p>	<p>To record NTSC signals or playback a NTSC tape, it will be necessary to select the appropriate mode.</p> <p>NTSC 3.58: To record NTSC signals or playback a NTSC tape. NTSC 4.43: To record NTSC4.43 signals or playback a NTSC4.43 tape. NTSC→PAL: To playback a NTSC tape on PAL TV.</p> <p>NOTES:</p> <ul style="list-style-type: none"> • The “NTSC→PAL” mode does not work during recording. In this mode, NTSC signals will be recorded as NTSC3.58. • The Menu screen is distorted during playing back a NTSC tape on PAL TV. Stop playback and access the Menu screen again. • In the “NTSC4.43” mode, with some TVs, on-screen displays (Program screen, etc.) may roll up or down and there may be a loss of colour. When this happens, select “NTSC3.58”. 				
<p>■ O.S.D. ON OFF</p>	<p>When this function is set to “ON”, various operational indicators appear on the TV screen.</p> <p>NOTES:</p> <ul style="list-style-type: none"> • When you use this unit as the source player for editing, be sure to set “O.S.D.” to “OFF” before starting. • During playback, the operation mode indicators may be disturbed depending on the type of tape being used. 				
<p>■ AUTO SP→LP TIMER ON OFF</p>	<p>When this function is set to “ON”, the unit automatically switches to LP mode to allow complete recording if there is not enough tape to record the entire programme while timer-recording in SP mode.</p> <p>For Example: Recording a programme of 210 minutes in length onto a 180-minute tape</p> <table border="1" data-bbox="467 962 1055 1049"> <tr> <td style="text-align: center;">Approximately 150 minutes</td> <td style="text-align: center;">Approximately 60 minutes</td> </tr> <tr> <td style="text-align: center;">SP mode</td> <td style="text-align: center;">LP mode</td> </tr> </table> <p style="text-align: center;">Total 210 minutes</p> <p>Make sure you set this function to “ON”, before the timer-recording starts.</p> <p>NOTES:</p> <ul style="list-style-type: none"> • If you have programmed the unit to timer-record 2 or more programmes, the second programme and those thereafter may not fit on the tape if you set “AUTO SP→LP TIMER” to “ON”. In this case, make sure the mode is not engaged, then set the tape speed manually during timer programming. • In order to ensure that the recording fits on the tape, this feature may leave a slight non-recorded section at the end of the tape. • There may be some noise and sound disturbance at the point on the tape where the unit switches from SP to LP mode. • The Auto SP→LP Timer feature is not available during ITR (Instant Timer Recording), and the feature will not work properly with any tapes longer than E-180, or with some tapes of shorter lengths. 	Approximately 150 minutes	Approximately 60 minutes	SP mode	LP mode
Approximately 150 minutes	Approximately 60 minutes				
SP mode	LP mode				

* The default setting is **bold** in the table below.

<p>■ VIDEO STABILIZER ON OFF</p>	<p>When this function is set to “ON”, you can automatically correct vertical vibration in the picture when playing back unstable recordings made on another recorder.</p> <p>NOTES:</p> <ul style="list-style-type: none"> ● When you finish viewing a tape, be sure to set this function to “OFF”. ● Regardless of the setting, this function has no effect during recording and during special effects playback. ● The on-screen display may jitter vertically when this function is set to “ON”. ● To watch recordings with close-caption, set this function to “OFF”.
<p>■ S-VHS ON OFF</p>	<p>Your unit can record in S-VHS (Super VHS), S-VHS ET or VHS.</p> <p>● To record in S-VHS: Set “S-VHS” to “ON”. Then, insert a cassette marked “S-VHS”. The S-VHS indicator lights up on the front display panel. The S-VHS recording mode is selected.</p> <p>● To record in S-VHS ET on a VHS cassette: Set “S-VHS ET” to “ON”. (☞ pg. 77) Then, insert a cassette marked “VHS”. The S-VHS indicator lights up on the front display panel.</p> <p>● To record in VHS: Insert a cassette marked “VHS”. Set “S-VHS ET” to “OFF”. (☞ pg. 77) The VHS recording mode is automatically selected regardless of the “S-VHS” mode setting.</p> <p>● To record in VHS on an S-VHS cassette: Insert a cassette marked “S-VHS”. The S-VHS indicator lights up on the front display panel. Then, set “S-VHS” to “OFF”. The S-VHS indicator goes off. The VHS recording mode is selected.</p> <p>NOTE: When playing back a tape that has been recorded in S-VHS or S-VHS ET, the S-VHS indicator lights up on the front display panel regardless of the “S-VHS” mode setting.</p>
<p>■ AUTO POWER OFF 3H OFF</p>	<p>When this function is set to “3H”, the unit is turned off automatically if no operation is done within 3 hours. “AUTO POWER OFF IN 3 MIN” appears on the screen 3 minutes before the unit is turned off.</p>

Mode Set

(DVD deck)

- Turn on the TV and select the video channel (or AV mode).
- Slide the TV/S-VHS/DVD switch to the right.

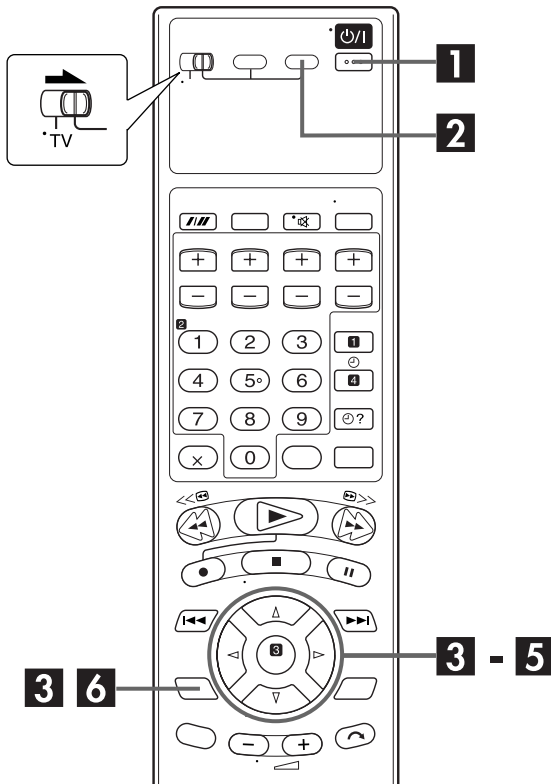

You can change various mode settings on the Mode Set screen by following the procedure described below.

- For each mode setting, see pages 81 to 82.

LANGUAGE	MENU LANGUAGE (pg. 21) AUDIO LANGUAGE (pg. 21) SUBTITLE (pg. 21) ON SCREEN LANGUAGE (pg. 21)
PICTURE	MONITOR TYPE (pg. 18) PROGRESSIVE MODE (pg. 19) SCREEN SAVER (pg. 81) MP3/JPEG (pg. 81)
AUDIO	DIGITAL AUDIO OUTPUT (pg. 81) ANALOG DOWN MIX (pg. 81) D. RANGE COMPRESSION (pg. 82)
OTHERS	RESUME (pg. 82) ON SCREEN GUIDE (pg. 82) PARENTAL LOCK (pg. 58)

- The procedure shows how to set “RESUME” to “ON” on the DVD Set Up menu screen as an example.

1 Turn on the unit.

Press /I.

2 Select the DVD deck.

On the unit

Press S-VHS/DVD repeatedly so that the DVD indicator lights up.

On the remote control

Press DVD so that the DVD indicator lights up.

3 Access the DVD Set Up menu screen.

1 Press SET UP MENU.

2 Press to select “OTHERS”.

- Each time you press the button, the setup menus change as follows;

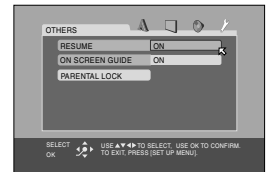

LANGUAGE → PICTURE → AUDIO → OTHERS
→ (Back to the beginning)

4 Select the mode.

Press to move to “RESUME”, then press OK.

5 Select the mode setting.

Press to select “ON”, then press OK.

6 Return to the normal screen.

Press SET UP MENU.

Picture Settings

* The default setting is **bold** in the table below.

<p>■ SCREEN SAVER ON OFF</p>	<p>The TV screen may be burned out if a static picture is displayed for a long time. When this function is set to "ON", the unit automatically activates the screen saver function if a static picture, such as an on-screen display or menu is displayed for over 5 minutes.</p> <p>NOTE: This function is not available for Audio CDs and MP3 discs.</p>
<p>■ MP3/JPEG MP3 JPEG</p>	<p>You can select files to play, when both MP3 files and JPEG files are recorded on a disc.</p> <p>MP3: Select this to play back MP3 files. JPEG: Select this to play back JPEG files.</p>

Audio Settings

* The default setting is **bold** in the table below.

<p>■ DIGITAL AUDIO OUTPUT PCM ONLY DOLBY DIGITAL/PCM STREAM/PCM</p>	<p>Set to the appropriate mode according to the type of the device connected to DIGITAL AUDIO OUT connector on the rear of unit. It is not necessary to set this mode when you connect no device to DIGITAL AUDIO OUT connector.</p> <p>PCM ONLY: Select this when you connect the unit's DIGITAL AUDIO OUT connector to the linear PCM digital input connector of other audio device.</p> <p>DOLBY DIGITAL/PCM: Select this when you connect the unit's DIGITAL AUDIO OUT connector to the digital input connector of a Dolby Digital decoder or an amplifier with a built-in Dolby Digital decoder.</p> <p>STREAM/PCM: Select this when you connect the unit's DIGITAL AUDIO OUT connector to the digital input connector of an amplifier with a built-in DTS, Dolby Digital, or MPEG multichannel decoder.</p>
<p>■ ANALOG DOWN MIX DOLBY SURROUND STEREO</p>	<p>Set to the appropriate mode according to your audio system when you play back a DVD VIDEO disc recorded with surround multichannel audio. This setting affects only the analogue audio output signal from the AUDIO OUT connectors (DVD) when playing back a DVD VIDEO disc recorded with surround multichannel audio.</p> <p>DOLBY SURROUND: Select this when you enjoy multichannel surround audio by connecting the unit's analogue AUDIO OUT connector (DVD) to a surround decoder or an internal amplifier.</p> <p>STEREO: Select this when you enjoy conventional 2-channel stereo audio by connecting the unit's analogue AUDIO OUT connectors (DVD) to a stereo amplifier/receiver or TV, or when you dub audio of a DVD VIDEO disc recorded with surround audio to your MD, cassette, etc.</p> <p>NOTE: The "ANALOG DOWN MIX" function does not work when the 3D Phonic function is activated. (☞ pg. 46)</p>

<p>■ D. RANGE COMPRESSION AUTO ON</p>	<p>You can compress the dynamic range (the difference between the loudest and quietest audio signals) of the sound when listening to the sound at a low volume or at night. This function is available with DVD VIDEO discs recorded with the Dolby Digital format. Set to the appropriate mode according to the number of channels recorded.</p> <p>AUTO: Audio is played back with channels other than Dolby Digital channel 1 or 2 compressed. ON: Audio is played back with all channel compressed.</p> <p>NOTES:</p> <ul style="list-style-type: none"> • It is recommended to set to "ON" when you enjoy surround sound at night. • The "D. RANGE COMPRESSION" function works only when playing back a disc recorded with Dolby Digital format. The setting is not effective for other discs. • The "D. RANGE COMPRESSION" function does not work when the 3D Phonic function is activated. (☞ pg. 46)
--	--

Playback discs	Output		
	STREAM/PCM	DOLBY DIGITAL/PCM	PCM ONLY
DVD VIDEO with 48/44.1 kHz, 16/20/24 bit linear PCM	48/44.1 kHz, 16/20/24 bit linear PCM		
DVD VIDEO with 96/88.2 kHz linear PCM	No output		
DVD VIDEO with DTS	DTS bitstream	48 kHz, 16 bit stereo linear PCM	
DVD VIDEO with Dolby Digital	Dolby Digital bitstream		48 kHz, 16 bit stereo linear PCM
Audio CD/Video CD	44.1 kHz, 16 bit stereo linear PCM		
Audio CD with DTS	DTS bitstream		

NOTES:

- The unit is not equipped with the DTS decoding function.
- When you play back a DVD VIDEO or Audio CD disc with DTS, use a DTS decoder to get correct signals from your speakers. Never use the unit's analog output connectors, which output incorrect signals that may damage your speakers.
- If you connect the analog outputs and digital outputs simultaneously, be sure to select the source of the amplifier correctly, or set the level control of the amplifier connected to the analog outputs to minimum.

Others Settings

* The default setting is **bold** in the table below.

<p>■ RESUME ON OFF</p>	<p>When this function is set to "ON", you can use the resume function. (☞ pg. 43)</p> <p>ON: You can start playback from the resume point if it is memorized. OFF: You cannot use the resume function.</p> <p>NOTE: This function is not available for Audio CDs and MP3 discs.</p>
<p>■ ON SCREEN GUIDE ON OFF</p>	<p>When this function is set to "ON", the unit can display "on-screen guide" icons or characters which shows the conditions of the unit or disc.</p>

Tuner Set

- Turn on the TV and select the video channel (or AV mode).
- Slide the TV/S-VHS/DVD switch to the right.

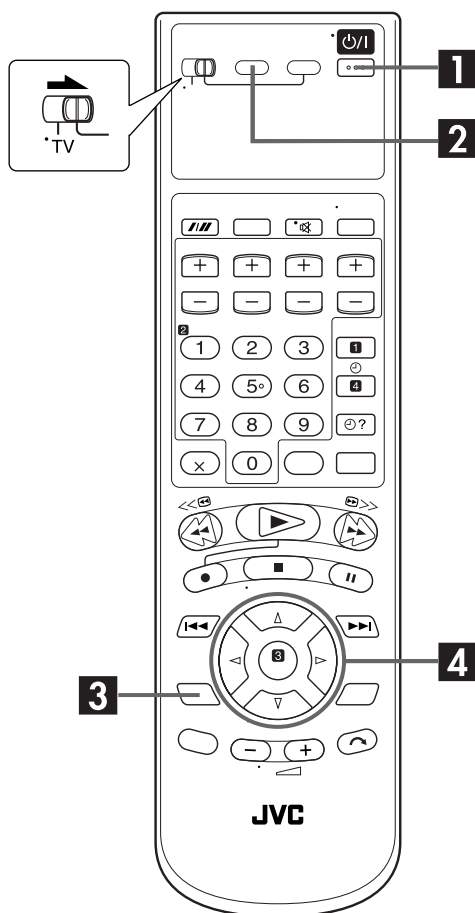

IMPORTANT

Perform the following steps only if —
 — Auto Channel Set has not been set correctly by Auto Set Up. (pg. 16)
 — you have moved to a different area or if a new station starts broadcasting in your area.

Your unit needs to memorize all necessary stations in channel positions in order to record TV programmes. Auto Channel Set automatically assigns all receivable stations in your area to call them up by using the **PR** buttons without going through any vacant channels.

Auto Channel Set

1 Turn on the unit.

Press **power**.

2 Select the S-VHS deck.

On the unit

Press **S-VHS/DVD** repeatedly so that the S-VHS indicator lights up.

On the remote control

Press **S-VHS** so that the S-VHS indicator lights up.

3 Access the Main Menu screen.

Press **SET UP MENU**.

4 Access the Auto Channel Set screen.

- 1 Press **up/down** to move the highlight bar (pointer) to "TUNER SET", then press **OK** or **right**.
- 2 Press **up/down** to move the highlight bar (pointer) to "AUTO CH SET", then press **OK** or **right**.

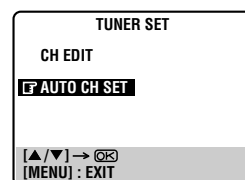

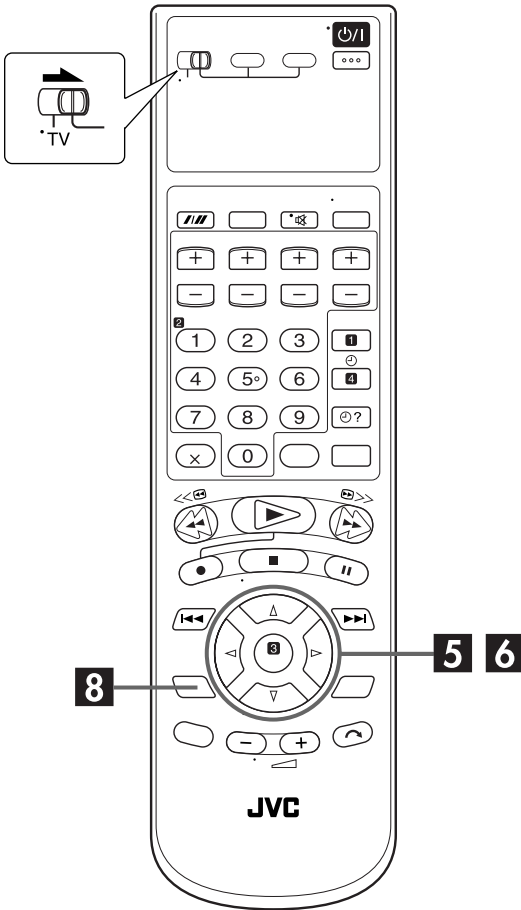

5 Select the TV system.

Press Δ/∇ to move the highlight bar (pointer) to the appropriate TV system (refer to the table below).

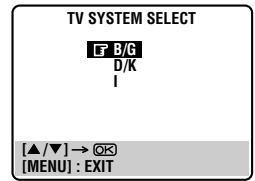

Major Countries/Areas	TV System
Australia, New Zealand, Kuwait, U.A.E., Indonesia, Singapore, Thailand, Malaysia, Iran, Saudi Arabia, Egypt, Morocco, Lebanon, Iraq	B/G
China, Mongolia, Russia	D/K
Hong Kong	I

6 Perform Auto Channel Set.

Press **OK** or \triangleright .

- The Auto Set screen appears, and remains on screen while the unit searches for receivable stations. As Auto Channel Set progresses, the "■" mark on the TV screen moves from left to right. Wait until the TV screen as shown in step 7 appears.

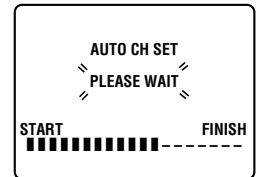

7 View the channel list screen.

After "SCAN COMPLETED" is displayed on the TV screen for about 5 seconds, the channel list screen looking like the one to the right appears. The stations your unit located appear on a channel list screen — channel position (CH), frequency ("FRQ") and TV system (SYS). The blueback screen and the programme currently being broadcast by the blinking station appear alternately for 8 seconds each. To view the next page, use the Δ/∇ button on the remote control.

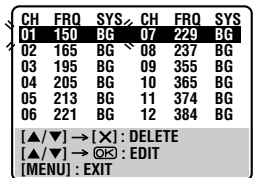

IMPORTANT

- When programming the timer using the G-CODE/SHOWVIEW system, be sure to check the desired channel is selected correctly. (☞ pg. 32, "G-CODE™/SHOWVIEW™ Timer Programming") (S-VHS deck only)
- Your unit memorizes all detected stations even if reception of some of them is poor. You can delete those stations with an unacceptable picture. (☞ pg. 86, "Delete A Channel")

NOTES:

- Fine tuning is performed automatically during Auto Channel Set. If you want to perform tuning manually, refer to page 86.
- If you perform Auto Channel Set when the aerial cable is not connected properly, "SCAN COMPLETED -NO SIGNAL-" appears on the TV screen in step 7. When this happens, make sure of the aerial connection and press **OK**; Auto Channel Set will take place again.
- If no sound accompanies the picture or the audio sounds unnatural on some channels that have been stored by Auto Set Up, the TV system setting for those channels may be incorrect. Select the appropriate TV system for those channels. (☞ pg. 86, "TV System Selection — When you see the picture but the audio can't be heard or sounds unnatural")

8 Return to the normal screen.

Press **SET UP MENU**.

- Using the Confirmation screen, you can delete channels, swap channel positions and fine-tune channels already stored. Refer to page 85 – 86 for the procedures.

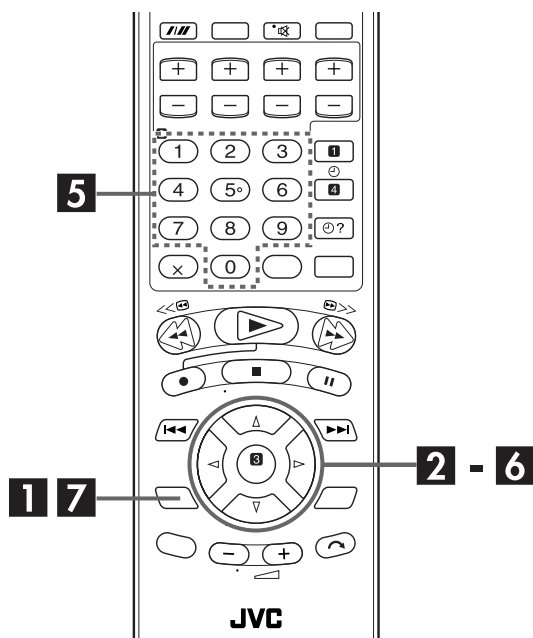

Manual Channel Set

Store channels that were not stored during Auto Set Up (pg. 16) or Auto Channel Set (pg. 83).

1 Access the Main Menu screen.

Press **SET UP MENU**.

2 Access the Tuner Set screen.

Press $\Delta \nabla$ to move the highlight bar (pointer) to "TUNER SET", then press **OK** or \triangleright .

3 Access the channel list.

Press $\Delta \nabla$ to move the highlight bar (pointer) to "CH EDIT", then press **OK** or \triangleright .

4 Select the channel position.

Press $\Delta \nabla$ to move the highlight bar (pointer) to an open channel position, then press **OK** or \triangleright .

5 Select the band.

Press $\Delta \nabla$ to move the highlight bar (pointer) to the desired band, then press **OK** to initiate Manual Channel Set.

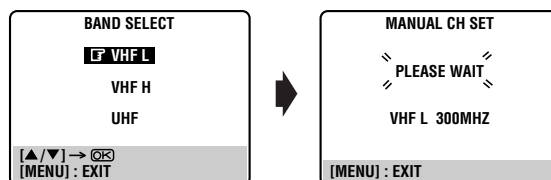

6 Set the station.

The screen to the right appears when a station is detected.

If you do not want to store the detected station...

Press $\Delta \nabla$ to move the highlight bar (pointer) to "CONTINUE", then press **OK** or \triangleright . Channel search will resume.

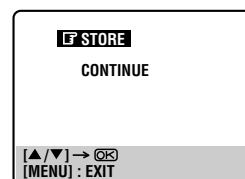

If you want to store the detected station...

Press $\Delta \nabla$ to move the highlight bar (pointer) to "STORE", then press **OK** or \triangleright . The Channel List appears again.

- The blueback screen and the TV picture currently being broadcast appear alternately for 8 seconds each.
- If you want to store another channel, repeat steps **4 - 6**.
- When channel search completes for that band, the Band Select screen appears again. To set channels for other bands, select another band and start Manual Channel Set again (steps **5** and **6**).

7 Return to the normal screen.

Press **SET UP MENU**.

- To change positions, see "Swap Channel Position" (pg. 86).

Delete A Channel

Perform steps 1 to 3 of “Manual Channel Set” on page 85 to access the channel list screen before continuing.

1 Select the channel.

Press Δ/∇ until the channel you want to delete begins blinking.

2 Delete a channel.

Press X.

- To re-store it, simply press \triangleleft .
- The item directly beneath the cancelled one moves up one line.
- Repeat steps 1 and 2 as necessary.

3 Return to the normal screen.

Press SET UP MENU.

Swap Channel Position

Perform steps 1 to 3 of “Manual Channel Set” on page 85 to access the channel list screen before continuing.

1 Select the position (e.g. 03).

Press Δ/∇ until the section of CH “03” begins blinking, then press OK or \triangleright .

- Only “03” will blink.

2 Select the position (e.g. 09).

Press **number keys** to input “0” and “9”.

- The two selected channels will be swapped.
- To cancel the channel swapping, press \triangleleft .

CH	FREQ	SYS	CH	FREQ	SYS
01	150	BG	07	229	BG
02	165	BG	08	237	BG
03	195	BG	09	355	BG
04	205	BG	10	365	BG
05	213	BG	11	374	BG
06	221	BG	12	384	BG

[0-9]: INPUT CH
[OK]: FINE TUNING
[MENU]: EXIT



CH	FREQ	SYS	CH	FREQ	SYS
01	150	BG	07	229	BG
02	165	BG	08	237	BG
05	355	BG	09	195	BG
04	205	BG	10	365	BG
05	213	BG	11	374	BG
06	221	BG	12	384	BG

[\triangleleft]: CANCEL
[OK]: OK
[MENU]: EXIT

- Repeat steps 1 and 2 as necessary.

3 Store the new position.

Press OK or \triangleright .

4 Return to the normal screen.

Press SET UP MENU.

Fine-Tuning Channels Already Stored

Perform steps 1 to 3 of “Manual Channel Set” on page 85 to access the channel list screen before continuing.

1 Select the channel to fine-tune.

Press Δ/∇ until the channel you want to tune begins blinking, then press OK **twice**.

- The “FRQ” number for the channel starts blinking.

2 Perform tuning.

Press Δ/∇ until the picture is its clearest. Then press OK or \triangleright .

- Repeat steps 1 and 2 as necessary.

3 Return to the normal screen.

Press SET UP MENU.

TV System Selection — When you see the picture but the audio can't be heard or sounds unnatural

Perform steps 1 to 3 of “Manual Channel Set” on page 85 to access the channel list screen before continuing.

1 Select the channel.

Press Δ/∇ until the channel you want to change its TV system begins blinking, then press OK **three times**.

- The “SYS” display for that channel starts blinking.

CH	FREQ	SYS	CH	FREQ	SYS
01	150	BG	07	229	BG
02	165	BG	08	237	BG
03	195	BG	09	355	BG
04	205	BG	10	365	BG
05	213	BG	11	374	BG
06	221	BG	12	384	BG

[Δ/∇]: SELECT SYSTEM
[OK]: OK
[MENU]: EXIT

2 Select the TV system.

Press Δ/∇ to select the appropriate TV system (BG \rightarrow DK \rightarrow I). Then press OK or \triangleright .

- Repeat steps 1 and 2 as necessary.

3 Return to the normal screen.

Press SET UP MENU.

Clock Set

- Turn on the TV and select the video channel (or AV mode).
- Slide the TV/S-VHS/DVD switch to the right.

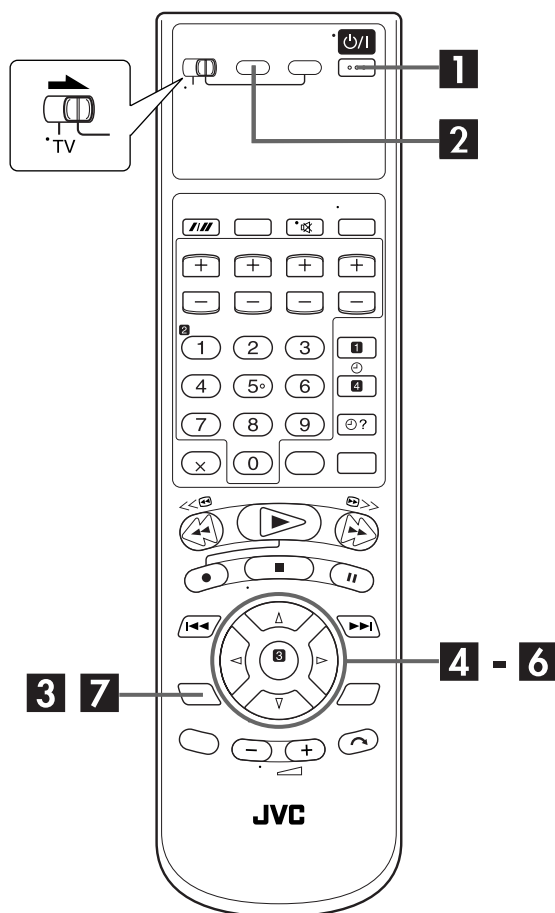

1 Turn on the unit.

Press P/I .

2 Select the S-VHS deck.

On the unit

Press **S-VHS/DVD** repeatedly so that the S-VHS indicator lights up.

On the remote control

Press **S-VHS** so that the S-VHS indicator lights up.

3 Access the Main Menu screen.

Press **SET UP MENU**.

4 Access the Initial Set screen.

Press Δ/∇ to move the highlight bar (pointer) to "INITIAL SET", then press **OK** or \triangleright .

5 Access the Clock Set screen.

Press Δ/∇ to move the highlight bar (pointer) to "CLOCK SET", then press **OK** or \triangleright . The Clock Set screen appears.

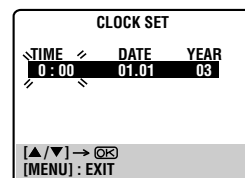
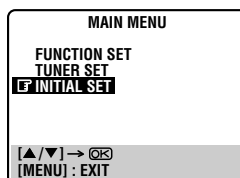

6 Set the date and time.

Press Δ/∇ to set the time, then press **OK** or \triangleright . The "DATE" display begins blinking. Repeat the same procedure to set the date and year.

- When you set the time, press and hold Δ/∇ to change the time by 30 minutes.
- When you set the date, press and hold Δ/∇ to change the date by 15 days.

7 Start the clock operation.

Press **SET UP MENU**.

NOTE:

When viewing NTSC tapes on a PAL TV set:

- The picture may shrink vertically with black bars appearing at the top and bottom of the screen. This is not a malfunction on the part of the unit nor the TV.
- The picture may roll up or down. This can be corrected using the V-HOLD control found on some TVs. (This cannot be corrected if the TV does not have a V-HOLD control.)
- During search, still, or frame-by-frame playback, the picture will be distorted, and there may be a loss of colour.

ATTENTION:

When this unit is connected to a multi-system TV, the audio signal may not be heard or may be noisy if the colour system select switch of the TV is adjusted to the AUTO position. In such a case, set the TV's colour system select switch to the appropriate position which corresponds to the TV system you have selected at the TV System Select screen.

Tape-To-Tape Editing

There are 4 different types of recorded tape, depending on the signal recorded.

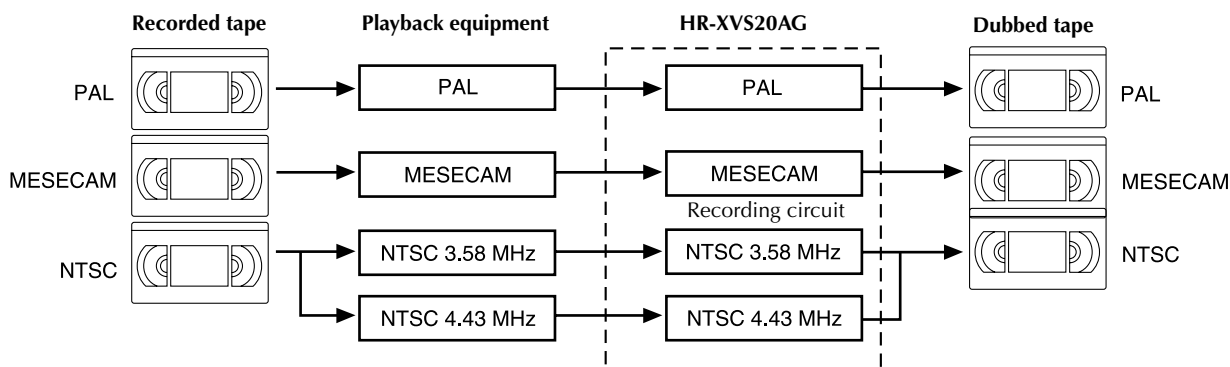

Before requesting service for a problem, use this chart and see if you can repair the trouble yourself. Small problems are often easily corrected, and this can save you the trouble of sending your unit off for repair.

POWER

SYMPTOM	POSSIBLE CAUSE	CORRECTIVE ACTION
1. No power is supplied to the unit.	• The mains power cord is disconnected.	Connect the mains power cord.
2. The remote control won't function.	• The batteries are discharged.	Replace the dead batteries with new ones.

TAPE TRANSPORT (S-VHS deck)

SYMPTOM	POSSIBLE CAUSE	CORRECTIVE ACTION
1. During recording, the tape does not run. "O" lights up and the channel display blinks on the front display panel.	• The unit is in the Record Pause mode.	Press ► to resume recording.
2. The tape will not rewind or fast-forward.	• The tape is already fully rewound or fast-forwarded.	Check the cassette.

PLAYBACK (S-VHS deck)

SYMPTOM	POSSIBLE CAUSE	CORRECTIVE ACTION
1. The S-VHS deck can not be operated.	• The S-VHS deck is not selected.	On the unit Press S-VHS/DVD repeatedly so that the S-VHS indicator lights up. On the remote control Press S-VHS so that the S-VHS indicator lights up.
2. The playback picture does not appear while the tape is running.	• If you are using the RF connection, — the TV receiver's channel selector is not set to the video channel. — the unit's video channel has not been correctly set. • If you are using the AV or S-VIDEO connection, the TV receiver is not set to the AV mode.	If you are using the RF connection, — set the TV receiver to the video channel. — perform "Video Channel Set" (☞ pg. 15). If you are using the AV or S-VIDEO connection, set the TV to its AV mode.
3. Noise appears during visual search.	• This is normal.	
4. Noise appears during normal playback.	• The automatic tracking mode is engaged.	Try manual tracking. (☞ pg. 26)
5. The playback picture is blurred or interrupted while TV broadcasts are clear or "USE CLEANING CASSETTE" message appears on the screen.	• The video heads may be dirty.	Use a dry cleaning cassette ECL-3F, or consult your JVC dealer.
6. Breaks are noticeable in Hi-Fi soundtrack.	• The automatic tracking mode is engaged.	Try manual tracking. (☞ pg. 26)
7. Playback picture has a loss of colour.	• The wrong colour system is selected for the tape being played back. • The wrong colour system was selected during recording.	Select the correct colour system. (☞ pg. 77, 78) Once recorded, the signal cannot be corrected. Be sure to choose the correct setting before recording.
8. No sound accompanies the playback picture.	• The TV system you have selected at the TV System Select screen is incorrect.	Set it to the correct position for the TV broadcast system used in your area. (☞ pg. 86)

PLAYBACK (DVD deck)

SYMPTOM	POSSIBLE CAUSE	CORRECTIVE ACTION
1. The button do not work.	<ul style="list-style-type: none"> The operation is prohibited on the placed disc. 	—
2. The DVD deck can not be operated.	<ul style="list-style-type: none"> The DVD deck is not selected. 	<p>On the unit Press S-VHS/DVD repeatedly so that the DVD indicator lights up.</p> <p>On the remote control Press DVD so that the DVD indicator lights up.</p>
3. "⊗" appears on the TV screen.	<ul style="list-style-type: none"> The operation is prohibited on the placed disc. 	—
4. "REGION CODE ERROR!" appears on the TV screen.	<ul style="list-style-type: none"> The disc's region number does not match that of the unit. 	Use the discs whose region number includes "ALL" or "4". (☞ pg. 5)
5. The disc cannot be played back.	<ul style="list-style-type: none"> The disc's region number does not match that of the unit. This type of the disc cannot be played back. The disc is not placed properly. The Parental Lock is engaged, and the placed disc is rated higher than the set level. 	<p>Use the discs whose region number includes "ALL" or "4". (☞ pg. 5)</p> <p>See "Unplayable Discs" (☞ pg. 5).</p> <p>Remove the disc, then place the disc properly in the disc tray. (☞ pg. 7, "Placing a Disc")</p> <p>Release the Parental Lock temporarily (☞ pg. 59), or change the set level (☞ pg. 59).</p>
6. The language is not played back as you set.	<ul style="list-style-type: none"> The disc does not contain the language you set. 	—
7. Changing audio/subtitle language is not possible.	<ul style="list-style-type: none"> The disc does not contain the audio/subtitle in the multiple languages. 	With some discs, the language should be set on the top menu. (☞ pg. 42)
8. The subtitles do not appears on the TV screen.	<ul style="list-style-type: none"> The disc does not contain the subtitles. The subtitle display is set to off. A-B Repeat Playback is in progress. (☞ pg. 51) 	<p>—</p> <p>Set the subtitles display to on. (☞ pg. 54)</p> <p>The subtitles recorded around A-B point may not appear.</p>
9. Angle cannot be changed.	<ul style="list-style-type: none"> The scene is not recorded from the multiple angles. 	—

MP3 Playback (DVD deck)

SYMPTOM	POSSIBLE CAUSE	CORRECTIVE ACTION
1. A disc cannot be played.	<ul style="list-style-type: none"> No MP3 files are recorded to the disc. MP3 files do not have the file extension in their file names. MP3 files are not recorded in a format compliant with ISO 9660 Level 1 or 2. The different types of files are recorded to the disc. 	<p>Replace the disc.</p> <p>Add correct file extension (.mp3, .Mp3, .mP3 or .MP3) to their file names.</p> <p>Replace the disc. (Record MP3 files using a compliant application.)</p> <p>The disc which contains the different types of files may not be played because of its disc characteristics or recording conditions.</p>
2. Not MP3 files but JPEG files are played.	<ul style="list-style-type: none"> The MP3/JPEG setting is set to "JPEG". 	<p>When both MP3 files and JPEG files are recorded to a disc, set "MP3/JPEG" to "MP3" to play MP3 files. (☞ pg. 81)</p>
3. The MP3 control display appears on the TV screen, but no operation can be performed.	<ul style="list-style-type: none"> No MP3 files or JPEG files are recorded to the disc, or the disc is an unplayable disc (such as CD-ROM). 	<p>Replace the disc. (☞ pg. 7)</p>

JPEG Playback (DVD deck)

SYMPTOM	POSSIBLE CAUSE	CORRECTIVE ACTION
1. A disc cannot be played.	<ul style="list-style-type: none"> No JPEG files are recorded to the disc. JPEG files do not have the correct file extension in their file names. JPEG files are not recorded in a format compliant with ISO 9660 Level 1 or 2. 	<p>Replace the disc.</p> <p>Add correct file extension (.jpg, .jpeg, .JPG, .JPEG or any uppercase and lowercase combination such as ".Jpg") to their file names.</p> <p>Replace the disc. (Record JPEG files using a compliant application.)</p>
2. Not JPEG files but MP3 files are played.	<ul style="list-style-type: none"> The MP3/JPEG setting is set to "MP3". 	<p>When both MP3 files and JPEG files are recorded to a disc, set "MP3/JPEG" to "JPEG" to play JPEG files. (☞ pg. 81)</p>

RECORDING (S-VHS deck)

SYMPTOM	POSSIBLE CAUSE	CORRECTIVE ACTION
1. Recording cannot be started.	<ul style="list-style-type: none"> There is no cassette loaded, or the cassette loaded has had its record safety tab removed. 	<p>Insert a cassette, or using adhesive tape, cover the hole where the tab was removed.</p>
2. TV broadcasts cannot be recorded.	<ul style="list-style-type: none"> "L-1", "L-2", "F-1" or "S-1" has been selected as the input mode. 	<p>Set to the desired channel.</p>
3. Tape-to-tape editing is not possible.	<ul style="list-style-type: none"> The source (another video recorder, camcorder) has not been properly connected. All necessary power switches have not been turned on. The input mode is not correct. 	<p>Confirm that the source is properly connected.</p> <p>Confirm that all units' power switches are turned on.</p> <p>Set the input mode to "L-1", "L-2", "F-1" or "S-1".</p>
4. Camcorder recording is not possible.	<ul style="list-style-type: none"> The camcorder has not been properly connected. The input mode is not correct. 	<p>Confirm that the camcorder is properly connected.</p> <p>Set the input mode to "L-1", "L-2", "F-1" or "S-1".</p>
5. "○" and "▷" on the front display panel won't stop blinking.	<ul style="list-style-type: none"> The end of the tape was reached during recording. 	<p>The programme may not have been recorded in its entirety. Next time make sure you have enough time on the tape to record the entire programme.</p>

TIMER RECORDING (S-VHS deck)

SYMPTOM	POSSIBLE CAUSE	CORRECTIVE ACTION
1. Timer recording won't work.	<ul style="list-style-type: none"> • The clock and/or the timer have been set incorrectly. • The timer is not engaged. 	<p>Re-perform the clock and/or timer settings.</p> <p>Press \ominus (TIMER) and confirm that "\ominus" is displayed on the front display panel.</p>
2. Timer programming is not possible.	<ul style="list-style-type: none"> • Timer recording is in progress. 	<p>Timer programming can't be performed while a timer recording is in progress. Wait until it finishes.</p>
3. " \ominus " on the front display panel won't stop blinking.	<ul style="list-style-type: none"> • The timer is engaged but there's no cassette loaded. 	<p>Load a cassette with the record safety tab intact.</p>
4. " \ominus ", " \circ " and " \triangleright " on the front display panel won't stop blinking.	<ul style="list-style-type: none"> • The loaded cassette has had its record safety tab removed. • The end of the tape was reached during timer recording. 	<p>Remove the cassette and cover the hole with adhesive tape, or insert a cassette with the record safety tab intact.</p> <p>The programme may not have been recorded in its entirety. Next time make sure you have enough time on the tape to record the entire programme.</p>
5. " \ominus " blinks for 10 seconds and the Timer mode is disengaged.	<ul style="list-style-type: none"> • \ominus (TIMER) has been pressed when there are no programs in memory, or the timer record information has been programmed incorrectly. 	<p>Check the programmed data and re-program as necessary, then press \ominus (TIMER) again.</p>
6. The G-CODE/SHOWVIEW system does not timer-record properly.	<ul style="list-style-type: none"> • The unit's channel positions have been set incorrectly. 	<p>Refer to "G-CODE™/SHOWVIEW™ Timer Programming" (pg. 32) and re-perform the procedure.</p>
7. " \circ " and " \triangleright " on the front display panel won't stop blinking.	<ul style="list-style-type: none"> • The end of the tape was reached during Instant Timer Recording. 	<p>The programme may not have been recorded in its entirety. Next time make sure you have enough time on the tape to record the entire programme.</p>
8. " $\&$ ", " \circ " and " \triangleright " on the front display panel won't stop blinking.	<ul style="list-style-type: none"> • The loaded cassette has had its record safety tab removed. • The end of the tape was reached during Automatic Satellite Programme Recording. 	<p>Remove the cassette and cover the hole with adhesive tape, or insert a cassette with the record safety tab intact.</p> <p>The programme may not have been recorded in its entirety. Next time make sure you have enough time on the tape to record the entire programme.</p>

OTHER PROBLEMS

SYMPTOM	POSSIBLE CAUSE	CORRECTIVE ACTION
1. The image of TV broadcast appears distorted on the TV screen.	<ul style="list-style-type: none"> The unit leaves turned on and the DVD deck is selected. 	Turn off the unit, or press S-VHS to select the S-VHS deck, then press TV/VCR so that the VCR indicator disappears from the front display panel.
2. Whistling or howling is heard from the TV during camcorder recording.	<ul style="list-style-type: none"> The camcorder's microphone is too close to the TV. The TV's volume is too high. 	Position the camcorder so its microphone is away from the TV. Turn the TV's volume down.
3. When scanning channels, some of them are skipped over.	<ul style="list-style-type: none"> Those channels have been designated to be skipped. 	If you need the skipped channels, restore them. (☞ pg. 85)
4. The channel cannot be changed.	<ul style="list-style-type: none"> Recording is in progress. 	Press II to pause the recording, change channels, then press ▶ to resume recording.
5. Channel settings that were made manually seem to have changed or disappeared.	<ul style="list-style-type: none"> After the manual settings were made, Auto Channel Set was performed. 	Perform manual setting again.
6. No channels are stored in the unit's memory.	<ul style="list-style-type: none"> The TV aerial cable was not connected to the unit when Auto Set Up was performed. 	Turn off the unit once and connect the TV aerial cable to the unit properly, then turn on the unit again. Then perform Auto Set Up again. (☞ pg. 16)

ATTENTION

This unit contains microcomputers. External electronic noise or interference could cause malfunctioning. In such cases, switch the unit off and unplug the mains power cord. Then plug it in again and turn the unit on. Take out the cassette. After checking the cassette, operate the unit as usual.

PLAYBACK

- Q. What happens if the end of the tape is reached during playback or search?**
- A. The tape is automatically rewound to the beginning.
- Q. During search, slow, still and frame-by-frame playback, I can't hear any audio. What's the problem?**
- A. This is normal.
- Q. Can the unit indefinitely remain in the still mode?**
- A. No. It stops automatically after 5 minutes to protect the heads.
- Q. When returning from search to normal playback, the picture is disturbed. Should I be concerned about this?**
- A. No, it is normal.
- Q. Noise bar appear during search. What's the problem?**
- A. This is normal.
- Q. Sometimes, during Index Search, the unit can't find the programme I want to see. Why not?**
- A. There may be index codes too close together.

RECORDING

- Q. When I pause and then resume a recording, the end of the recording before the pause is overlapped by the beginning of the continuation of recording. Why does this happen?**
- A. This is normal. It reduces distortion at the pause and resume points.
- Q. Can the unit indefinitely remain in the Record-Pause mode?**
- A. No. The unit goes to its Stop mode automatically after 5 minutes to protect the heads.
- Q. What happens if the tape runs out during recording?**
- A. The unit stops recording, and "○" and "▷" on the front display panel won't stop blinking.

TIMER RECORDING

- Q. "○" and "⊖" remain lit on the front display panel. Is there a problem?**
- A. No. This is a normal condition for a timer recording in progress.
- Q. Can I programme the timer while I'm watching a tape or a TV broadcast?**
- A. You won't see the picture as it is replaced by the on-screen menu, but the audio from the programme or tape you're viewing can be heard.

GENERAL

Power requirement	: AC 110 V – 240 V~, 50 Hz/60 Hz
Power consumption	
Power on	: 28 W
Power off	: 5.0 W
Temperature	
Operating	: 5°C to 40°C
Storage	: -20°C to 60°C
Operating position	: Horizontal only
Dimensions (WxHxD)	
	: 435 mm x 98 mm x 357 mm
Weight	: 4.8 kg
Format	: S-VHS/VHS standard
Maximum recording time	
(SP)	: 240 min. with E-240 video cassette (PAL/MESECAM)
	: 160 min. with T-160 video cassette (NTSC)
(LP)	: 480 min. with E-240 video cassette (PAL/MESECAM)
(EP)	: 480 min. with T-160 video cassette (NTSC)

VIDEO/AUDIO (S-VHS deck)

Signal system	: PAL-type colour signal and CCIR monochrome signal, 625 lines 50 fields NTSC colour and EIA monochrome signal, 525 lines/60 fields
Recording system	: DA4 (Double Azimuth) head helical scan system
Signal-to-noise ratio	: 45 dB
Horizontal resolution	
	: 250 lines (PAL/MESECAM) 220 lines (NTSC)
Frequency range	: 70 Hz to 10,000 Hz (Normal audio) 20 Hz to 20,000 Hz (Hi-Fi audio)
Input/Output	: RCA connectors: IN x 2, OUT x 1 S-Video connector: IN x 2, OUT x 1

VIDEO/AUDIO (DVD deck)

Signal system	: PAL
Applicable disc	: DVD (12 cm, 8 cm) CD (12 cm, 8 cm)
Audio characteristics	
DVD	: 4 Hz – 22 KHz
Frequency response	
CD	: 4 Hz – 20 KHz
S/N Ratio	: 90 dB
Harmonic distortion	
	: 0.1 %
Wow and flutter	: Below Measurable Level
Dynamic range	: 90 dB
Output	
Component-Y	: (RCA) 1.0 Vp-p/75 ohm
Component-P _B /P _R	
	: (RCA) 0.7 Vp-p/75 ohm
Audio	: (RCA) 2 Vrms, 1 Kohm
Digital Audio	: 0.5 Vp-p/75 ohm
Pickup	
CD	
	: Wavelength : 775 – 805 nm Maximum output power : 0.5 mW
DVD	
	: Wavelength : 640 – 660 nm Maximum output power : 1.0 mW

TUNER/TIMER (S-VHS deck)

TV channel storage capacity	: 99 positions (+AUX position)
Tuning system	: Frequency synthesized tuner
Channel coverage	
VHF	: (low) 42 MHz – 175 MHz (high) 175 MHz – 470 MHz
UHF	: 470 MHz – 870 MHz
Aerial output	: UHF channels (Adjustable E28 – E60)
Memory backup time	: Approx. 10 min.

ACCESSORIES

Provided accessories	
	: RF cable, S-Video cable, Infrared remote control unit, "R6" battery x 2

Specifications shown are for SP mode unless otherwise specified.

E.& O.E. Design and specifications subject to change without notice.

A		I	
A-B Repeat Playback	51	INDEX	8
About Discs		Index Search	25
JPEG	65	Information on Multi-System Compatibility	
MP3	62	(S-VHS deck only)	88
Placing a Disc	7	Instant Timer Recording (ITR)	28
Playable Discs	5		
Region Number	5	J	
Unplayable Discs	5	JPEG control display	65
Angle Selection	55		
Audio Channel Selection	57	L	
Audio Language Selection	56	Language	20
Auto Channel Set	83	Language Code List	22
Auto Set Up	16	Menu/Audio/Subtitle Language Set	
Automatic Satellite Programme Recording	39	(DVD deck only)	21
		On-screen Language Set (DVD deck)	20
C		Letter Box	18
Chapter Search	51	Locating the start point of the item or	
Check, cancel and change programmes	36	skip the item	43
Clock Set	87		
Component Video Connection	14	M	
Connecting To A Dolby Digital Decoder or		Manual Channel Set	85
An Amplifier With A Built-in DTS	75	Manual Tracking	26
Connecting To A Satellite Receiver	74	Mode Set (DVD deck)	
		ANALOG DOWN MIX	81
D		AUDIO LANGUAGE	21
Delete A Channel	86	D. RANGE COMPRESSION	82
Digest	44	DIGITAL AUDIO OUT	81
Digital Audio Dubbing	71	MENU LANGUAGE	21
Disc menu	42	MONITOR TYPE	18
Dubbing (from DVD to S-VHS)	70	MP3/JPEG	81
		ON SCREEN GUIDE	82
E		ON SCREEN LANGUAGE	21
EDITING (DVD DECK)		PROGRESSIVE MODE	19
Digital Audio Dubbing	71	RESUME	82
EDITING (S-VHS DECK)		SCREEN SAVER	81
Dubbing (from DVD to S-VHS)	70	SUBTITLE	21
Edit From A Camcorder	68	Mode Set (S-VHS deck)	
Edit To Or From Another Video Recorder	69	AUTO POWER OFF	79
Elapsed Recording Time Indication	29	AUTO SP→LP TIMER	78
Express Timer Programming	34	B.E.S.T.	30, 77
		NTSC	78
F		O.S.D.	78
File/group selection	67	PAL/MESECAM	77
Fine-Tuning Channels Already Stored	86	PICTURE CONTROL	77
		S-VHS	79
G		S-VHS ET	77, 79
G-CODE™/SHOWVIEW™ System Setup	31	VIDEO STABILIZER	79
G-CODE™/SHOWVIEW™ Timer Programming	32	MP3 control display	62
Guide Program Number Set	31, 33		
H			
High-Speed (Turbo) Search	24		
High-Speed Search	43		

N		V	
Next Function Memory	26	VFP function	47
O		Video Channel Set	15
OPERATIONS ON DVD DECK	40 – 67	W	
OPERATIONS ON S-VHS DECK	23 – 39	When programmes overlap each other	38
P		Z	
Pan&Scan	18	Zooming	45
Parental Lock		3D Phonic	46
Country/Area Code List	60		
To change the settings	59		
To set Parental Lock for the first time	58		
To temporarily release the Parental Lock	59		
Playback (DVD deck)	40 – 53		
Playback (JPEG)	66 – 67		
Playback (MP3)	63 – 64		
Playback (S-VHS deck)	23 – 26		
Playback Control (PBC) Function	41, 52		
Programme Playback	53		
R			
Random Playback	53		
Record One Programme While Watching			
Another	28		
Recording	27 – 30		
Region Number	5		
Remote Control Functions	72		
Repeat Playback	26, 50, 64, 67		
Resume Function	43		
S			
Scan Mode Set			
PROGRESSIVE MODE	19		
Skip Search	25		
Slow Motion	24, 43		
Soundtrack Selection	26		
Still Picture/Frame-By-Frame Playback	24, 43		
Strobe Playback	45		
Subtitle Selection	54		
S-VHS	69		
S-VIDEO Connection	13		
Swap Channel Position	86		
T			
Tape Position Indicator	10		
Tape Remaining Time	29		
Time Search	52		
Timer Recording	32 – 39		
Top menu	42		
Track/group selection	64		
Tuner Set	83 – 86		
TV System Selection	86		

